

# RADIO NEWS ★

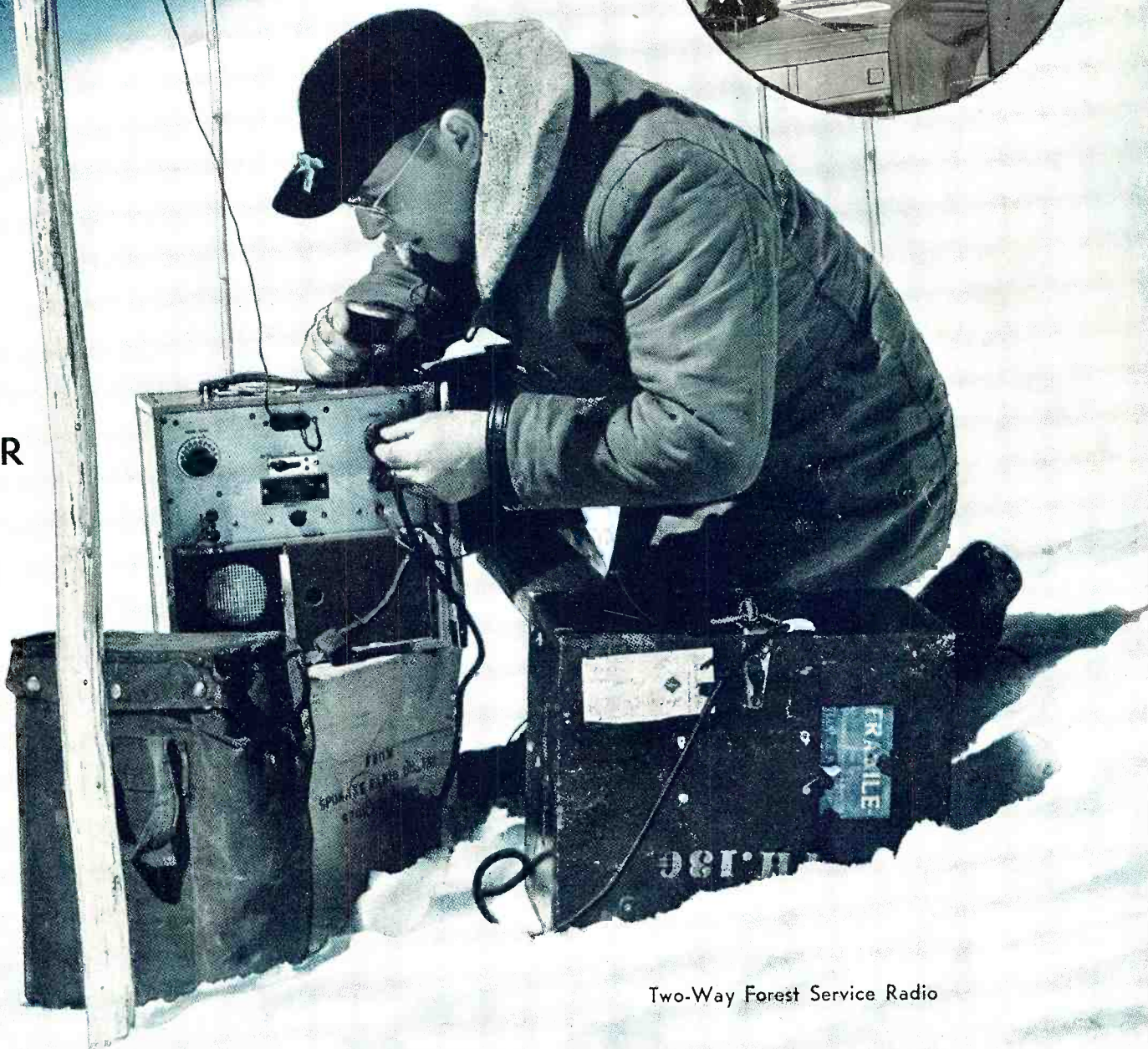

DECEMBER  
1942  
25c  
In Canada 30c

Two-Way Forest Service Radio

**SPECIAL FEATURES ON ELECTRONICS**  
★ THE MEASUREMENT OF AUDIO FREQUENCIES ★



## A Book Worth Owning...



Have you a few well-read and well-beloved books in your library that you wouldn't part with at any price? We suggest you add another . . . because once you've read even a few chapters, you'll agree with hundreds of radio servicemen, engineers, amateurs . . . the new **MYE TECHNICAL MANUAL** is a book worth owning.

Many hundreds of copies of this book are being distributed to military radio instructors . . . in training centers of the Army, Navy and Marine Corps, including the Air Forces. Once you glance through this list of chapter headings, you'll understand why.

- 1 Loud Speakers and Their Use
- 2 Superheterodyne First Detectors and Oscillators
- 3 Half-Wave and Voltage Doubler Power Supplies
- 4 Vibrator and Vibrator Power Supplies
- 5 Phono-Radio Service Data
- 6 Automatic Tuning—operation and adjustment
- 7 Frequency Modulation
- 8 Television—suggestions for the postwar boom
- 9 Capacitors—how to overcome wartime shortages
- 10 Practical Radio Noise Suppression
- 11 Vacuum Tube Voltmeters
- 12 Useful Servicing Information
- 13 Receiving Tube Characteristics—of all American tube types

Just one suggestion. We know you'll want a copy of this manual eventually. It contains 392 pages of information as down-to-earth as a soldering iron, as indispensable as a voltmeter. It's beautifully bound,

with hard cloth covers. It's worth far more than its price, \$2.00 net to servicemen.

But the supply for civilian use is limited. It will pay you, in the time, effort and money this book can save you *now*, to waste no time in going to your Mallory Distributor to reserve a copy. Order your **MYE TECHNICAL MANUAL** today!

**P. R. MALLORY & CO., Inc., INDIANAPOLIS, INDIANA**  
Cable—PELMALLO



**J. E. SMITH, President,**  
National Radio Institute, Established 28 Years.

He has directed the training of more men for the Radio Industry than any other man in America.

# I will send you a Lesson Free to show how I train you at home in spare time for Good Jobs in Radio



Broadcasting and other types of Radio Stations employ Radio Technicians and Operators with average pay among the country's highest paid industries.



Radio Repairing, a booming business right now, with no new sets being made, pays many \$30, \$40, \$50 a week for full time—others \$5, \$10 extra a week for spare time work.



Radio Operators find good jobs with Government Departments, Shipping Companies and in Commercial Aviation; opportunities are increasing in these fields.

## I Trained These Men



Chief Operator Broadcasting Station

"Before I completed your lessons, I obtained my Radio Broadcast Operator's license and immediately joined Station WMIC where I am now Chief Operator." **HOLIS E. HAYES, 827 Madison St., LaPeer, Mich.**

Lieutenant in Signal Corps

"I cannot divulge any information as to my type of work but I can say that N.R.I. training is certainly coming in mighty handy these days." (Name and address omitted for military reasons.)



\$10 a Week in Spare Time



"I repaired some Radio sets when I was on my tenth lesson. I really don't see how you can give so much for such a small amount of money. I made \$600 in a year and a half, and I have made an average of \$10 a week just spare time." **JOHN JERRY, 1337 Kalamath St., Denver, Colorado.**

Mail the Coupon for a FREE lesson from my Radio Course. It shows you how N.R.I. trains you for Radio at home in spare time. And with this sample lesson I'll send my 64-page illustrated book, RICH REWARDS IN RADIO. It describes the many fascinating jobs Radio offers, explains how N.R.I. teaches you with interesting, illustrated lessons and SIX BIG KITS OF RADIO PARTS!

**Act Now! Many Radio Technicians Make \$30, \$40, \$50 a Week**

Right now, in nearly every neighborhood, there's room for a spare and full time Radio Technician. Many Radio Technicians are stepping into good spare time and full time Radio Jobs, or are starting their own shops, and are making \$30, \$40, \$50 a week!

Others take good-pay jobs with Broadcasting Stations. Hundreds more are needed for Government jobs as Civilian Radio Operators, Technicians. Radio Manufacturers, rushing to fill Government orders, need trained men. Aviation, Police,

Commercial Radio and Loud-speaker Systems are live, growing fields. And think of the NEW jobs Television and other Radio developments will open after the war! I give you the Radio knowledge required for these fields.

**How My "50-50 Method" Helps Many Make \$5, \$10 a Week EXTRA While Learning**

Many N.R.I. Students make \$5, \$10 a week extra money fixing Radios in spare time while learning. I send EXTRA MONEY JOB SHEETS that tell how to do it!

My "50-50 Method"—half building and testing Radio Circuits with the six kits of Radio parts I send, half learning from illustrated lessons—makes you "old friends" with Radio before you know it. You run your own Spare Time Shop, get practice fixing Radios, get paid while training!

**Find Out What N.R.I. Can Do for You**

MAIL THE COUPON for FREE sample lesson and my 64-page book. You'll discover things you never knew about Broadcasting, Radio Servicing, Manufacturing, other interesting, profitable Radio fields. You'll read a complete description of my Course—"50-50 Method"—SIX KITS OF RADIO PARTS—Extra Money Job Sheets. You'll see the many fascinating jobs Radio offers and how you can get started. You'll read letters from many men I trained. Mail Coupon AT ONCE! **J. E. SMITH, President, Dept. 2NR, National Radio Institute, Washington, D. C.**

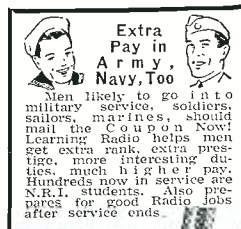

Men likely to go into military service, soldiers, sailors, marines, should mail the Coupon Now! Learning Radio helps men get extra rank, extra prestige, more interesting duties, much higher pay. Hundreds now in service are N.R.I. students. Also prepares for good Radio jobs after service ends.



**TRAINING MEN FOR VITAL RADIO JOBS**

## FREE TRIAL LESSON

I will send you FREE a sample lesson. "Getting Acquainted with Radio Servicing" to show you how practical it is to train for a good-pay Radio job at home in spare time. It's a valuable lesson. Study it—keep it—without any obligation whatsoever. Tells how Superheterodyne Receivers work—why Radio Tubes fail—how to fix Electro-dynamic Loudspeakers and Output Transformers—how Gang Tuning Condensers work. Gives hints on I.E. Transformer Repair—how to locate defective soldered joints—Antenna Oscillator Coil Facts—Receiver Servicing Technique—dozens of other hints, facts, explanations. Illustrated with 31 photos, sketches, drawings. Get your copy at once. Mail Coupon NOW!

## Good for Both 64 PAGE BOOK SAMPLE LESSON Free

**J. E. SMITH, President, Dept. 2NR, National Radio Institute, Washington, D. C.**

Without obligating me, mail your Sample Lesson and 64-page Book FREE. I am particularly interested in the branch of Radio checked below. (No salesman will call. Write plainly.)

- |  |  |
|--|--|
| <input type="checkbox"/> Radio Service Business of My Own    | <input type="checkbox"/> Aviation Radio                  |
| <input type="checkbox"/> Service Technician for Radio Stores | <input type="checkbox"/> Operating Broadcasting Stations |
| <input type="checkbox"/> Spare Time Radio Servicing          | <input type="checkbox"/> Army, Navy Radio                |
| <input type="checkbox"/> Auto Radio Technician               | <input type="checkbox"/> Operating Police Radio Stations |
|  | <input type="checkbox"/> Operating Ship and Harbor Radio |

(If you have not decided which branch you prefer—mail coupon for facts to help you decide.)

Name..... Age.....  
Address.....  
City..... State..... 4FR-2





★Leading the Industry Since 1919

The Technical Magazine devoted to Radio in War, including articles for the Serviceman, Dealer, Recordist, Experimenter and Amateur



WE HAVE just completed a trip to Washington and other eastern points to find literally hundreds of beehives of radio activity.

We met many of the officers and civilians who are doing much to further the all-out war effort, and their reactions to the Special November Signal Corps Issue of RADIO NEWS were most favorable.

We had an interesting talk with the Chief Signal Officer, Maj. Gen. Dawson Olmstead. Those of you who have read the Signal Corps Issue realize the tremendous scope of this important branch of our armed services, and after meeting and talking to the General, we can well understand why the Signal Corps is functioning at such a high degree of perfection.

We again visited Fort Monmouth, home of the Signal Corps, and there met many old friends. Later, we were privileged to visit Col. R. V. D. Corput Jr., Director of the RADAR Laboratories. While we cannot reveal the results of our observations, we can tell you that this important branch of the Signal Corps is playing a vital role in the defense of our country by literally "pulling out of the hat" radio developments of such magnitude as to tax the imagination.

Another visit took us through the (Continued on page 76)

Contents

FEATURES

THE ELECTRIC EYE IN ELECTRONICS... Willard D. Stewart 6
CIVILIAN TRAINING IN OUR WAR EFFORT... Col. Louis B. Bender 10
ELECTRONIC TUBES AND THEIR APPLICATIONS... Martin E. Franklin 14
THE MEASUREMENT OF AUDIO FREQUENCIES... Rufus P. Turner 17
WARTIME PROGRESS IN ELECTRONICS... Robert Eichberg 20
ELECTRONIC TIME... Guy Dexter 22
112-120 MC EMERGENCY PORTABLE... Oliver Read 26
FUNDAMENTAL ATOMIC PHYSICS... C. D. Prater 29
TRAINING RADIO OPS FOR THE AIRLINES... Lewis Winner 34
ELECTRONIC DETECTIVES... Seldon Summers 40
INDUSTRIAL SOUND FOR WAR PRODUCTION... Sidney Harman and Haskel A. Blair 42
EQUIPMENT FOR FOREST DEFENSE... S. R. Winters 48

DEPARTMENTS

AVIATION RADIO COURSE, PART 8... Paul W. Karrol 31
PRACTICAL RADIO COURSE, PART 9... Alfred A. Ghirardi 32
SPOT RADIO NEWS... Lewis Winner 44
MFRS. LITERATURE .... 37 BOOK REVIEW ..... 38
23 YEARS AGO IN RADIO 37 QRD? De Gy..... 38
WHAT'S NEW IN RADIO..... 39

Copyright 1942
ZIFF-DAVIS PUBLISHING COMPANY
Member of the Audit Bureau of Circulations

Table with 4 columns: Name, Title, Name, Title, Name, Title, Name, Title. Includes William B. Ziff (Publisher), B. G. Davis (Editor), C. R. Tighe (Ass't to Publisher), Oliver Read (Managing Editor), R. B. Frank (Tech. Ed.), William A. Stocklin (Associate Editor), Herman R. Bollin (Art Director), S. L. Cahn (Advertising Mgr.), J. M. Eckert (Midwest Adm. Mgr.), H. G. Strong (Circulation Mgr.).

RADIO NEWS is published monthly by the Ziff-Davis Publishing Company at 540 N. Michigan Ave., Chicago, Ill. New York Office, 270 Madison Ave. Washington Bureau, Occidental Hotel, Lt. Col. Harold E. Hertney, Mgr. Subscription Rates: In U. S. \$3.00 per year, single copies, 25 cents; in South and Central America and U. S. Possessions, \$3.00 per year; in Canada \$3.50 per year, single copies 30 cents; in British Empire, \$3.75 per year; all other foreign countries \$6.00 per year.

# TRAIN NOW FOR RADIO

... but read this message before investing your money

Never before has there been such a demand for trained radio men—in industry as well as in the military services. This means you'll want to act now—and act fast. But remember this before you buy your training: You can pay all sorts of prices. You can read all sorts of advertising claims. But why guess? Be safe, sure, and positive! Get your training from this one inexpensive book that has given more people their basic radio training than any other ever published—the book that can pave your way to a fascinating future in any of Radio's many branches such as servicing, aviation, military, broadcasting, electronics, manufacturing, public address, etc.

## COMPARE BEFORE YOU BUY!

Compare before you buy! See for yourself how Ghirardi's RADIO PHYSICS COURSE tops other books to an amazing extent that is instantly obvious upon examination and comparison. It is larger, (has 972 pages), is far more thorough, has more really helpful illustrations.

## MAXIMUM TRAINING—MINIMUM TIME—LOWEST COST

Because it does not take any previous electrical or radio knowledge for granted but explains every detail simply, clearly, and thoroughly, it makes Radio much more easily understandable, and is widely endorsed by eminent authorities, and more widely used by both civilian and government schools than any other book on the market. In short, it is the one truly complete book that is a simplified, thorough Radio Course in itself right through the newest things in Radio, Television, Etc., and which has the added advantage of containing the all-essential foundation knowledge of Electricity (over 300 pages on this subject alone).



Alfred A. Ghirardi

Used in more U. S. Signal Corps, Navy, and civilian school and college radio courses than any other radio text book!

## OTHER BOOKS BY RADIO'S BEST-KNOWN INSTRUCTOR



Ghirardi's MODERN RADIO SERVICING

### THE BOOK FOR NEW SERVICEMEN

Ghirardi's MODERN RADIO SERVICING is the only single book that covers modern radio testing instruments, troubleshooting and repair procedure completely. A comprehensive, 1300-page, home-study course on the entire art of radio repair work, containing 706 illustrations and 720 review questions. Essential for the man who wants to start on a profitable radio servicing career—and equally so for the man already in Radio who recognizes the need for becoming more proficient under pressure of today's vast amount of repair work.

Only \$5 Complete

## HOW TO DO MORE SERVICE WORK—FASTER—MORE PROFITABLY



Ghirardi's TROUBLESHOOTER'S HANDBOOK

When an ailing radio comes in for repair, simply turn to the Troubleshooter's Handbook—and chances are, you'll find just the clue and detailed information you need to repair it—without lost time, and without elaborate testing. Provides 710 pages of factual troubleshooting and repair data on 4600 new and old models; 66 big sections of charts, tables containing thousands of items of service data indexed for split-second reference—including over 400 pages of new, factory-checked, time-saving repair job information never before published. It's a 710-page manual-size gold mine of practical servicing information!

It's a book that pays for itself on a single repair job by quickly giving the help you need—when you need it! Smart, practical servicemen everywhere use it on all their jobs.

ONLY \$5 Complete

Ghirardi's famous RADIO PHYSICS COURSE is a miracle of modern radio training. Everything that can be done to make learning radio EASY for you has been done in this widely acclaimed book—even the 836 self-testing review questions at the ends of the chapters help you check your own progress every step of the way.

## MAKES RADIO STUDY EASIER

That is why thousands of civilians and men studying radio in the armed forces report that Ghirardi's RADIO PHYSICS COURSE has made the study of radio easier and more interesting for them than has any other radio book or radio course they have ever seen or used. What's more, the complete 972-page RADIO PHYSICS COURSE costs you but \$5—only a fraction of the price you might expect to pay for such thorough, top-notch radio instruction.

## DON'T GUESS!

Don't guess! See Ghirardi's RADIO PHYSICS COURSE. Compare it with any other. You be the judge. If you do not agree 100% it is the course for you—then return it and your money will be cheerfully refunded! You cannot lose!

## HOME STUDY—THE EASY WAY!

- 972 BIG pages
- 508 clear illustrations
- 856 self-testing Review Questions

## ★ EXPECT TO BE INDUCTED? ★

### Then Learn Radio Now—Prepare for Higher Pay—Faster Promotion—More Interesting Duty

Think what a knowledge of Radio might mean to you when you enter the Army or Navy! Now—before you are inducted—is the time to start, and the place to start is with Ghirardi's RADIO PHYSICS COURSE—the very same book that is used as a text in the Radio Technician's Courses of the U. S. Signal Corps. Radio Training is an asset that can mean much, both now and in years to come—and this book is the way to get it—quickly—in spare time—and at absolute minimum cost!

A Complete Radio Training at but a fraction of the price you might expect to pay **ONLY \$500**

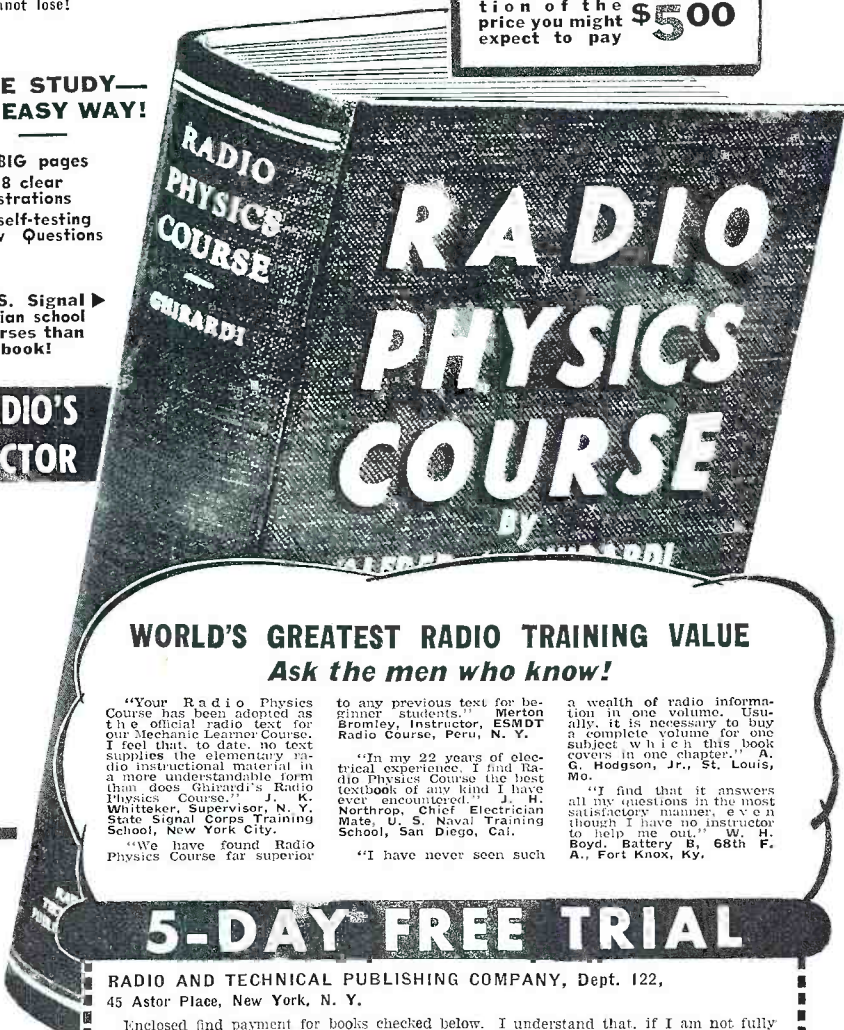

## WORLD'S GREATEST RADIO TRAINING VALUE Ask the men who know!

"Your Radio Physics Course has been adopted as the official radio text for our Mechanic Learner Course. I feel that, to date, no text supplies the elementary radio instructional material in a more understandable form than does Ghirardi's Radio Physics Course." J. K. Whitaker, Supervisor, N. Y. State Signal Corps Training School, New York City.

"To any previous text for beginner students." Merton Bromley, Instructor, ESMOT Radio Course, Peru, N. Y.

"In my 22 years of electrical experience, I find Radio Physics Course the best textbook of any kind I have ever encountered." J. H. Northrop, Chief Electrician Mate, U. S. Naval Training School, San Diego, Cal.

"I have never seen such a wealth of radio information in one volume. Usually, it is necessary to buy a complete volume for one subject which this book covers in one chapter." A. G. Hodgson, Jr., St. Louis, Mo.

"I find that it answers all my questions in the most satisfactory manner, even though I have no instructor to help me out." W. H. Boyd, Battery B, 68th F. A., Fort Knox, Ky.

## 5-DAY FREE TRIAL

RADIO AND TECHNICAL PUBLISHING COMPANY, Dept. 122, 45 Astor Place, New York, N. Y.

Enclosed find payment for books checked below. I understand that, if I am not fully satisfied, I may return them at the end of 5 days and receive my money back.

- Ghirardi's Radio Physics Course, \$5. (\$5.50 foreign)
- Revised Radio Troubleshooter's Handbook, \$5. (\$5.50 foreign)
- Modern Radio Servicing, \$5. (\$5.50 foreign)
- MONEY SAVING COMBINATION—The Handbook and Modern Radio Servicing at special price of only \$9.50 for the two (\$10.50 foreign)
- Rush free literature on all of above

Name .....

Address .....

City .....

State .....

**ABSOLUTE MONEY-BACK GUARANTEE NO QUESTIONS ASKED YOU CANNOT LOSE!**

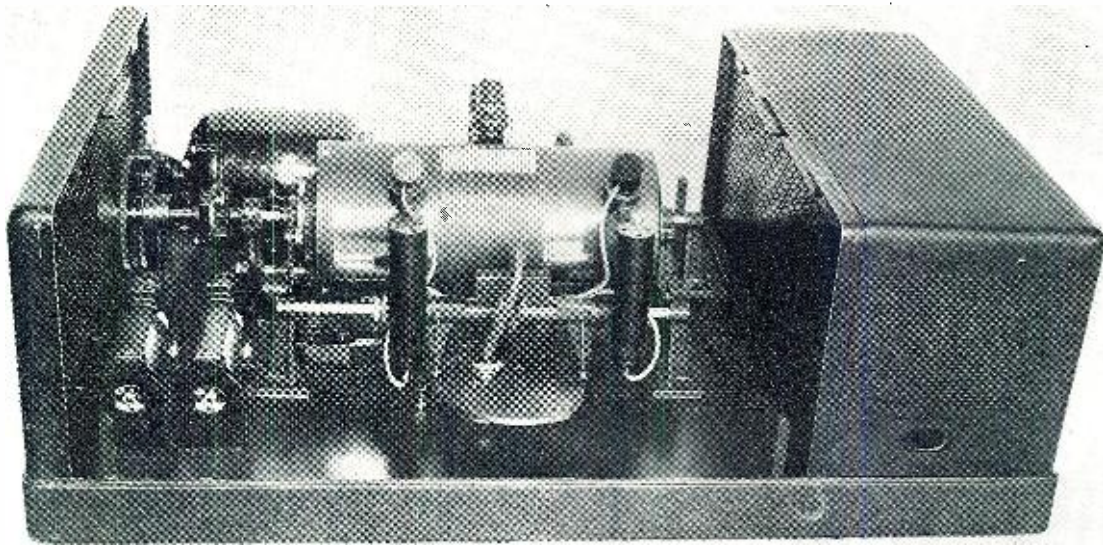

An elaborate photoelectrically operated time-telling device.

# The Electric Eye in Electronics

by **WILLARD D. STEWART**

Electronics Engineer

***A comprehensive analysis of the electrical unit that is playing an important role in the science of electronics.***

IN the study of electronics, photoelectric phenomena occupies an undeniably vital position. It does so because not only has it been responsible for a majority of developments, but because it has, to a great extent, prompted the new tremendous sweep of interest on the subject of electronics today.

In photoelectric phenomena we are concerned with the electric eye, of which there are two types. One is the photoconductive type or the selenium resistance cell. The other is the photoemissive type. In this group we find the barrier-layer group composed of copper oxide rectifier cells, the selenium rectifier cells, electrolytic type cells and the popular tube group. In this tube category we find the vacuum or gas filled photo-tubes.

The most common of the photoconductive cells is the selenium resistance cell. It consists, essentially, of a thin film of selenium generally deposited on an insulating plate between two electrodes. The forming of these electrodes is usually accomplished by depositing a conductive layer on a plate of glass or other insulating medium, and then engraving a zig-zag line from one corner of the glass to the other. In this way, the conducting layer is separated by a fine line of substantial length. The selenium that

is coated over the entire plate in a thin layer thus serves to connect the two electrodes and form the resistance cell. For protection the selenium may be protected by a coating of varnish, a glass plate, or it may be enclosed within a glass bulb.

As we know, this cell is affected by light, thus providing its activating usefulness. Just how this cell is affected by light is graphically illustrated in Fig. 1. It will be noted that there is a finite value of resistance,  $L_0$ , when no light is applied, and a maximum value of resistance,  $L_{00}$ , for large quantities of light. Now in Fig. 2, we see the light-input current-output characteristic and the light-input photocell-resistance characteristic for a typical selenium resistance photoconductive cell. A study of this graph will reveal that

when extremely small or extremely large amounts of light are directed on the photocell, the percentage variation of photocell current or resistance is small. It becomes evident therefore that the range of light intensities for which this cell is useful is limited. This is particularly so since the so-called "dark-resistance" and "minimum resistance" are not absolutely stable. As a result of these deficiencies, this type cell has not achieved the popularity of the others.

Now let us analyze the other type of electric eye, the photoemissive type, which is the most popular. In this type cell, we have an actual transfer of electrons from one medium to another, as between the layers of a barrier layer cell, and from the photo cathode into a gas or vacuum, in the tube type emissive photocells.

Electrons move about with random velocities within all conducting materials. If the tests are conducted at room temperature, some of the electrons may have sufficient velocity to leave the surface of the conductor. However, when the temperature is increased, the electrons become highly energized, and many more will thus leave the surface of the conductor. But, before leaving the surface of the conductor, each electron must have sufficient speed to overcome a certain

Fig. 1.

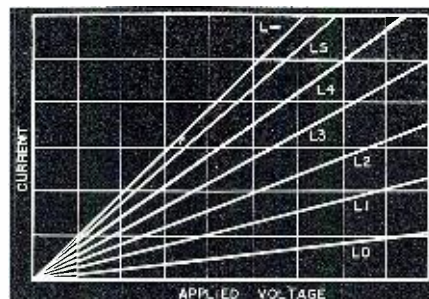

barrier potential, which appears at the surface of the conductor and which varies in value with the type of conductor, and the material to which it is adjacent. This particular characteristic is usually referred to as the work function of the material.

Since light is a form of radiant energy, it has the power of stimulating or

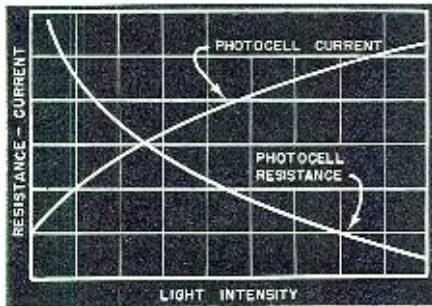

Fig. 2.

accelerating electrons, with which it comes in contact. Thus it has the power to increase the velocities of the electrons at the surface of a conductor to such an extent that the quantity leaving the surface will be greatly increased. We also find that the velocity given to the electrons is dependent on the energy level of the light, but not the quantity. This, in turn is proportional to the frequency, or inversely proportional to the wavelength of the light. Therefore if the work function of the conducting material is very low, long wave, infra-red light may supply a high enough energy level to release electrons. But, if the work function is very high, the material

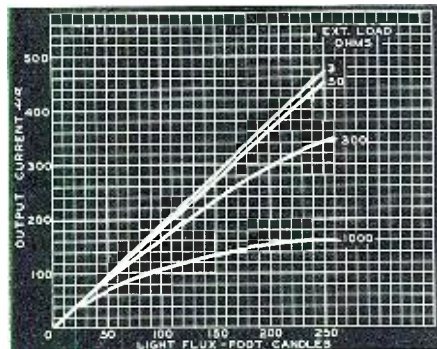

Fig. 3.

may not emit many electrons even when it is energized by ultra-violet light.

Many other factors may destroy the sensitivity of photosensitive materials to short wavelength light. For instance, we may have a conductor that is sensitive to infra-red radiation that may not, however, be always sensitive to ultra-violet radiation. Fortunately, there are several ways of using the electrons thus released. In the barrier-layer type cells, such as the copper oxide cell, the self-generating type of selenium cell, or the electrolytic cells, electrons are given sufficient energy by the light to penetrate a rectifying or barrier layer of oxide or other substance. This permits the electrons to build up sufficient voltage across this layer to cause current to flow through

within a circuit connected externally.

This cell action is referred to as the "photo-voltaic cell," and is capable of supplying relatively large amounts of current. Therefore it is suitable for operating meters and super-sensitive relays directly. However since its voltage output is relatively low, it does not lend itself readily to photo amplifier use, except for frequencies within certain ranges. These may be amplified by coupling the photocell into an amplifier through an impedance matching transformer.

A typical barrier-layer type cell, such as the Photronic cell, has the light-input, current-output characteristics shown in Fig. 3. The relative output characteristics of this type cell at various wavelengths are shown in Fig. 4. So that the comparative and relative properties may be appreciated, the characteristics of sun light, tungsten light and the human eye are also shown in this chart. A study of these properties reveals that the human eye has a relatively narrow range of sensitivity.

Let us now turn our attention to the phototubes. In the conventional types,

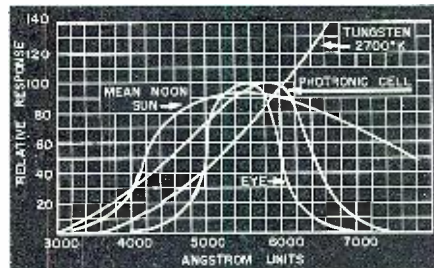
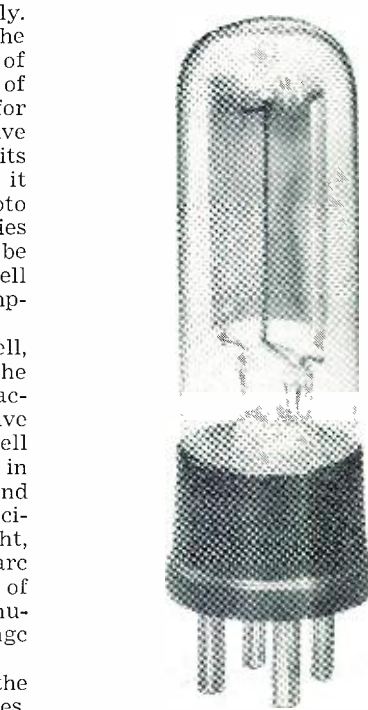

Fig. 4.

most of the electrons released from the photosensitive material, or the photo cathode, are collected by another electrode, an anode, within the tube. The characteristic results of such activity are shown in Fig. 5. The anode in this tube is generally maintained at a positive enough potential to collect most of the electrons released from the photo-sensitive material by the light. When the potentials are in excess of this value, little or no change in the number of elec-



G-E Type PJ, or FJ photoelectric tube.

trons being released from the photo cathode, is produced.

The gas filled phototube contains a small amount of inert gas. Ionization of this gas by collision with the electrons causes some of the gas molecules within the tube to break up into positive ions and negative electrons. Since these ions and electrons flow respectively to the cathode and anode of the tube, the total current output of the phototube is increased. This is illustrated in Fig. 6.

We note that as the voltage is increased, the speed of the electrons is increased until finally a point is reached where the collisions from the primary and the secondary electrons are frequent and violent enough to cause the tube current to maintain itself in a continuous glow discharge. This is the breakdown area. However before this "self-sustaining" point is reached, the quantity and velocity of the positive ions reaching the photo

Fig. 5.

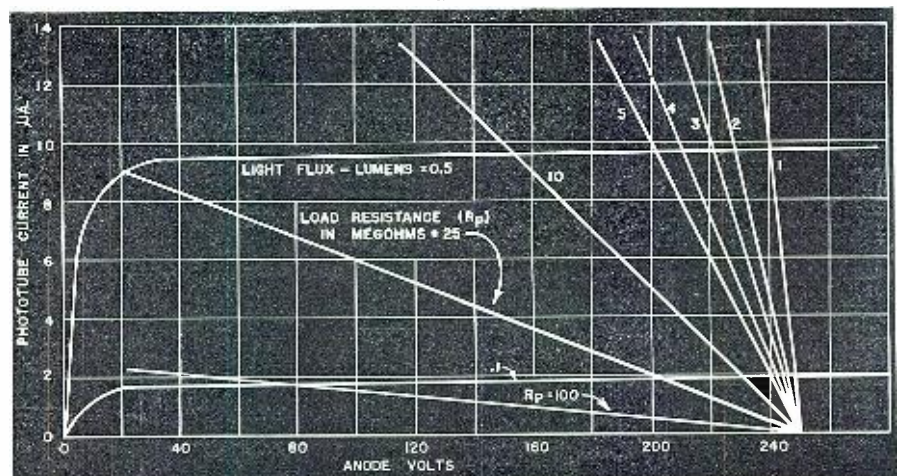



Front view of G-E Type FJ-405.

cathode are great enough to seriously damage the photo cathode. This is illustrated as the unstable area. Accordingly, the maximum supply voltage for gas filled phototubes is generally limited to about 50, and less when relatively large amounts of light are used. When using an ordinary gas

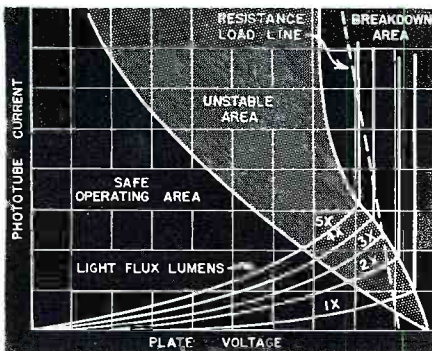
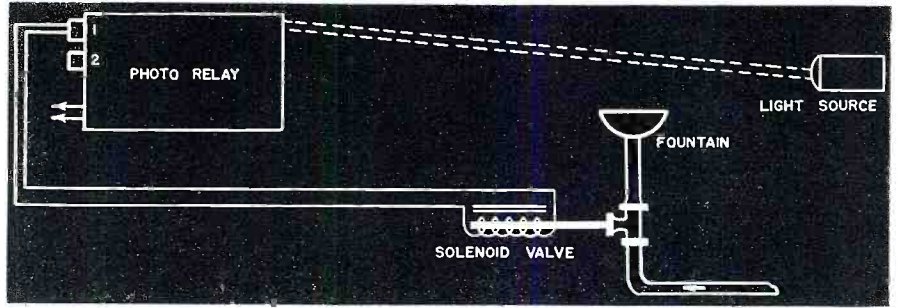

Fig. 6.

filled tube, the current and voltage should never be allowed to rise above shaded area shown in this illustration.

Since as we have found, changes in the phototube supply voltage produce relatively small changes in the phototube current, relatively high values of resistance can be placed in series with the phototube to obtain relatively large voltage outputs from small amounts of light. This voltage, in turn, can be introduced into an amplifier, using one or more tubes.

In such amplifiers, it is essential that the filament or heater of the tube be operated at low temperature, so that it will not heat the grid sufficiently to cause emission of an appreciable number of electrons. In addition, the plate current within the tube also must be kept low. Thus the bombardment of



A photoelectrically controlled drinking fountain.

the gas molecules within the tube will create but few positive ions, most of which will flow to the grid. A typical one-stage photo amplifier with relay action is shown in Fig. 7.

Where only extremely small phototube currents are available, a two stage amplifier, as shown in Fig. 8, is necessary. In this instance, low power voltage amplifier tubes can be coupled to the voltage across the phototube load resistor, and the voltage drop

that the effects of relatively high grid currents of a power output tube, supplying large amounts of energy to a relay, are negligible. It is thus evident that the gain in sensitivity and stability may be much greater than the increased amplification due to the added voltage amplifier. In the amplifier illustrated, it is possible to obtain relatively high sensitivity and stability, and is useful where the speed of operation is not greater than five per sec.

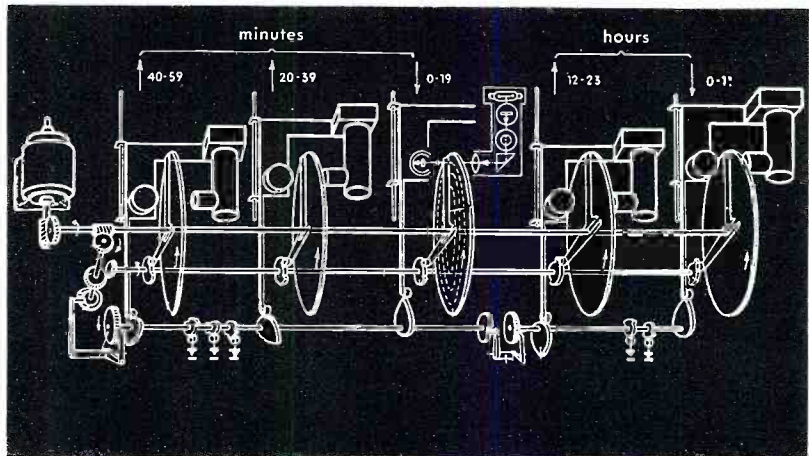

Block diagram of the photoelectric timetelling device.

across the load resistor of the voltage amplifier can be used as the control voltage to the grid of the output tube. By using this method a voltage amplifier having low cathode heater power and low cathode current, and thus extremely low grid emission and gas currents to the grid, can be used to respond to the small voltage drops across extremely high value resistors, without appreciably affecting the values of these voltage drops.

The plate circuit load in the voltage amplifier can be kept low enough so

One of the most important requisites of any photo relay system is the light source. Naturally, in order to obtain the maximum efficiency from such a system, as much light as is practicable should be available. It has been found that the greatest quantity of light can be had on the phototube when a filament of high surface temperature is used, and when a lens of the greatest possible efficiency is used. In this instance, the lens should have the greatest possible area. Oddly enough the focal length of the lens does not affect

Fig. 7.

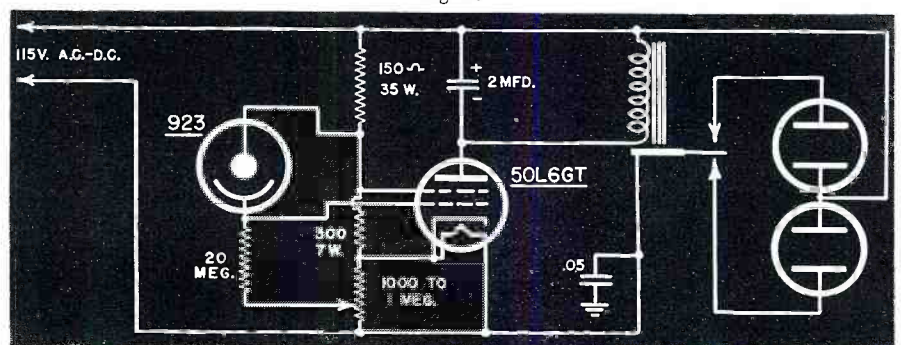



the brilliance of the image, at any one point of the image. The image will be small if a long focal lens is used, and thus may not completely cover the phototube.

Accordingly, to secure the maximum amount of light, the focal length of the lens must be short enough so that the image or part of the image of the incandescent filament will completely cover the photo tube. It thus can be seen that if the image of the filament does completely cover the phototube, the actual size of the filament does not affect the quantity of light received by the phototube. It is thus possible to use a relatively small and low powered filament in connection with a short focal length or high magnification lens, to be assured of the maximum degree of light at the phototube.

It has been found in actual practice that when a low current filament is used, it is practicable to use a voltage dropping resistor in series with the filament across the power supply line. By adopting this method, the lamp can be used in series with the filaments of the amplifier. This saves the expense of a relatively costly expensive power transformer. In addition it makes practicable the use of the light source on a direct or alternating current source of supply.

In those installations where extremely long life, ruggedness and reliability are essential, a heavy filament automobile headlight type bulb is used. When this type bulb is used, a low magnification (long focal length) lens can be used. Because the filament is large, it isn't necessary to have much magnification, for the image covers the phototube anyway.

Wartime hazards have increased the use of invisible light beams, instead of the visible. It is possible to obtain filters that will absorb the greater portion of the visible light spectrum, while passing the infra-red part of the spectrum, to which the phototube is sensitive. One of most popular filters is the dark red gelatine type. It is relatively efficient and where for example, all trace of light must be eliminated, red and blue gelatine filters

can be obtained and combined to produce an effective visible light absorption unit. Although glass has been used in filter systems, tests have shown that the gelatine materials are more transparent to the infra-red rays than the glass.

The next essential in a photo relay system, when the light source is operated in series with the filaments of the amplifiers, is a mirror. This is used to reflect the light back onto the phototube of the photo relay unit. The mirror used must have a true polished surface, and have an area at least equal to the average diameter of

the lens and the phototube openings.

The phototube, in alliance with simple or elaborate amplifier systems, has been used for the control of machines, illuminations, counting; detecting metals; smoke indicators; clarity and turbidity control; color measurement; color density; temperature control; glare, opacity and light transmission; drinking fountain control; control of power plant operation; control of sprays on lumber painting machine; register control and hundreds of other similar applications.

Among the unusual in photoelectric devices is the spectrophotometer, now in use at the Materials Laboratory of the Army Air Forces. This device can distinguish between two million shades of color. At the present, the use of the device applies particularly to the standardization of camouflage colors, color characteristics of luminescent materials and measurement of light transmission and reflection of transparent plastics. In the latter case, for example, color curves are obtained on plastics used, in airplane windows or turrets, both before and after the material has undergone Florida exposure or accelerated weathering tests to determine the effect of the exposures on the light transmission or light reflection of the materials.

In time and weather-telling devices, used here and abroad also appear the phototubes and suitable amplifiers. In

(Continued on page 56)

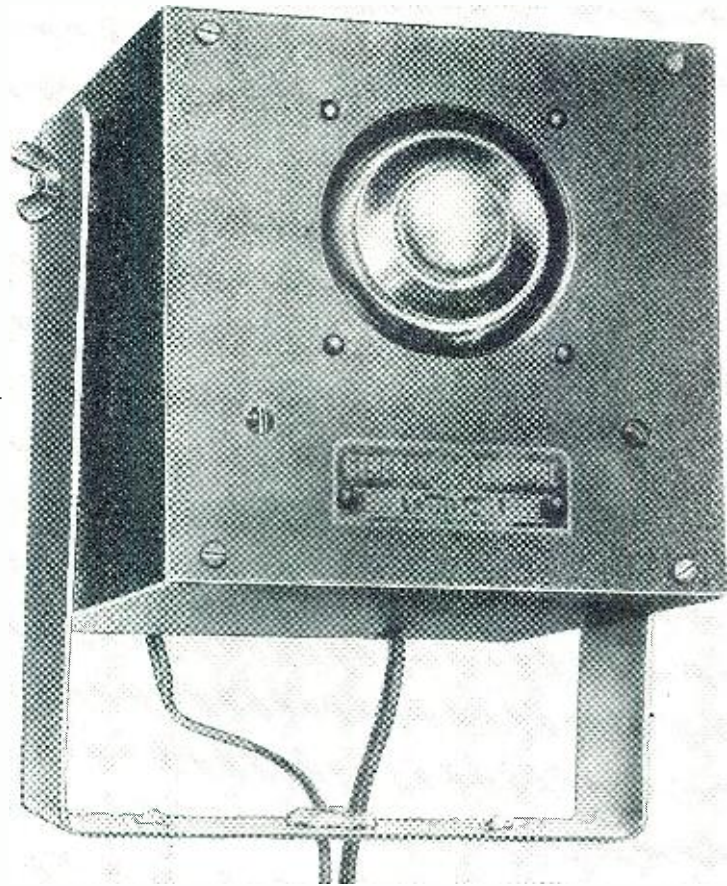

G-E photoelectric relay-table mounted.

Fig. 8.

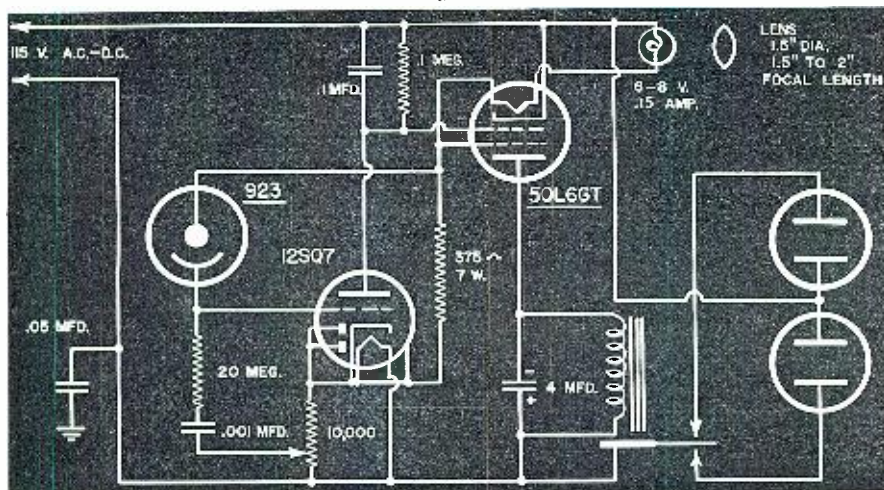

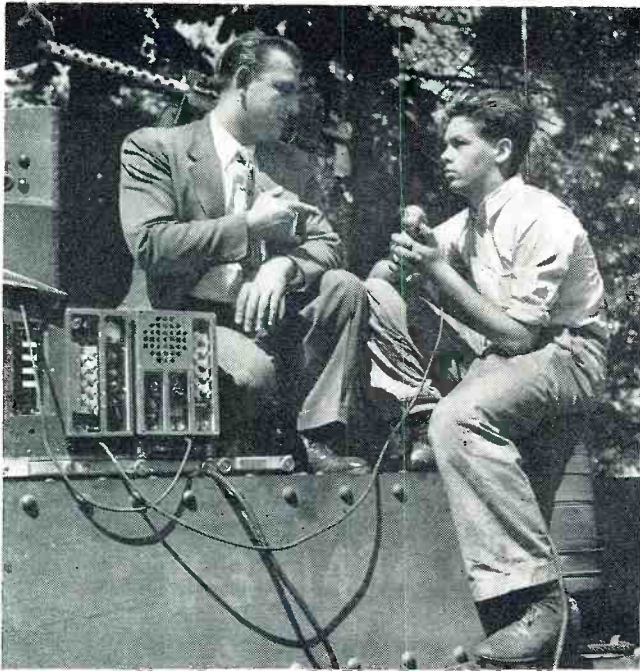

Instructor gives data on the operation of a tank radio. These men learn installation in addition to maintenance.

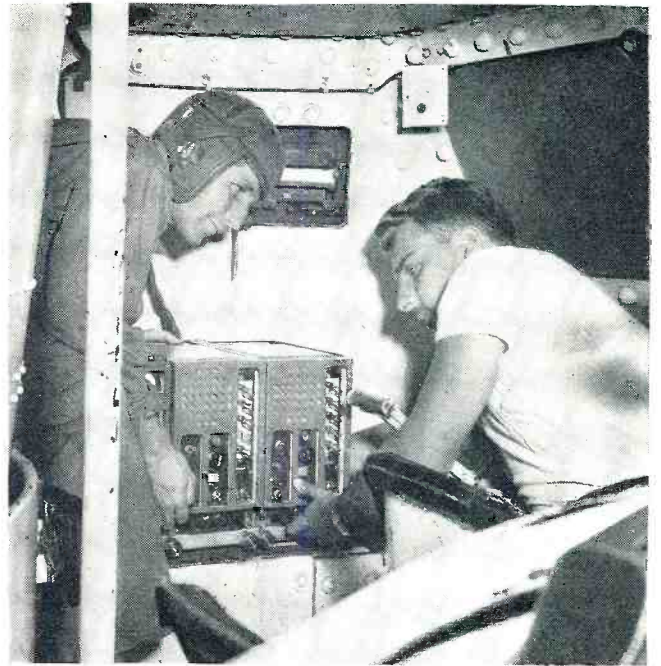

Every precaution is taken when installing radio sets to guarantee trouble-free performance while in combat.

# ★ CIVILIAN TRAINING

by Col. LOUIS B. BENDER

*Back of the military men in uniform is the vast army of civilian technical specialists who have put their shoulders to the wheel—in "getting the message through"*

Outmoded tanks and other vehicles find valuable service at civilian schools for installation and service work.

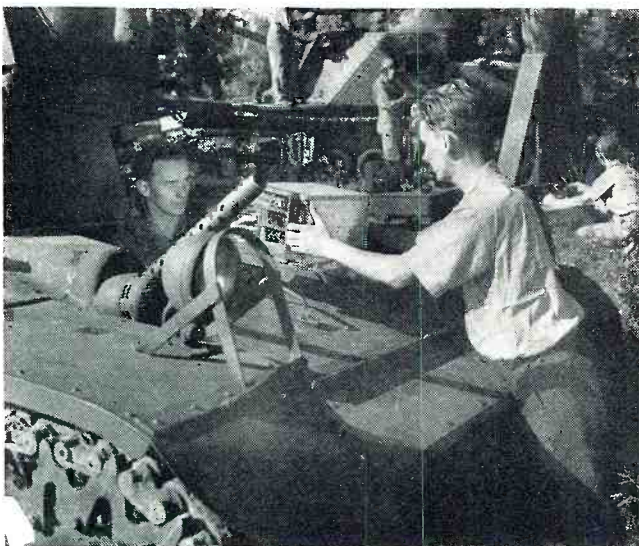

Learning how to connect antennae for efficient operation. This includes both electrical and mechanical techniques.





Students learn to test and analyze all sorts of radio equipment in one of the many well-equipped classrooms.

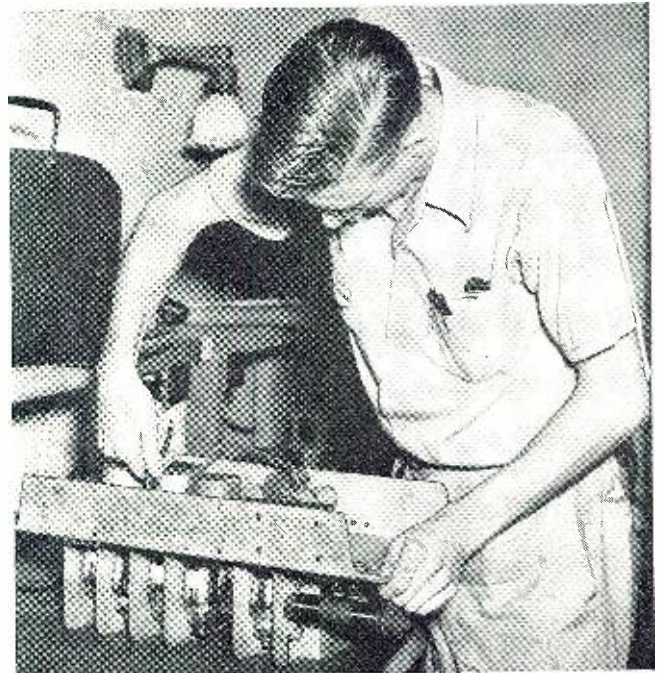

Shop practice includes actual wiring of transmitters and receivers. Soldering is of greatest importance.

# IN OUR WAR EFFORT ☆

▼ TODAY, a virtually new, uncanny element is being injected with - - startling dispatch into a war that, in reality, encompasses the world. People are aware of the powers of gun power and steel. They are familiar with the force of tanks and submarines and planes. Only now, however, they are beginning to recognize in a vague sort of way at least that an entirely new military weapon is back of all the fire power of rifles, cannons, tanks and planes. The spotlight is beginning to turn more and more toward Communications—the keystone of the current war.

This war is a war of speed. Time and space have been shortened. The combat zone disregards geographical boundaries as well as political ones. And, as the conflict expands, America moves outward with it and her first line of defense as well as her first weapon of offense, no matter where her interests lie, is Communication.

Military communications must have the speed of light—almost the speed of thought. Between all military units, wherever they may be and in whatever circumstance, there must be split-second coordination. There is no time to hang two lights in the belfry. There is no time to ride through every village and farm. Loss of communications can mean a loss of victory. "Get the Message Through!" Now!

This Moment! Supercommunications! That's the job of the Signal Corps of the U. S. Army. Public attention is beginning to focus on the Signal Corps as the branch of our armed forces that is developing, maintaining, supplying and using the implements and the apparatus that make supercommunications possible.

The troops that wear the crossed flags and torch insignia of the Signal Corps go into the front lines of combat and maintain communication under fire. They are assigned to all Army organizations, from the Division up through the Field Army. They are with the infantry, artillery, armored units, the air corps, with all the arms of the Army. In the ranks of the Signal Corps are thousands of specialists who repair, maintain and service the equipment of supercommunications. They are the experts who prepare codes and ciphers for the Army. They are the technicians who supervise military communication by radio, telephone, telegraph and teletype. They are the specialists who locate unauthorized or enemy radio stations. They are the trained men who operate that super-mechanical equipment. Abroad and at home the Signal Corps is on the alert using the swiftest, surest and safest method possible to bring America on to victory.

From a comparatively small unit

before the war started, the Signal Corps has developed into a large organization that stacks up well with the six other major branches in the Service of Supply. Yet it still needs men. It needs men and wants men with outstanding ability. It will accept men who are imbued with American courage and resourcefulness and who want to live the life of a hero. Men who enter the Corps with a hobby will leave it with a vocation; and those who enter with a vocation will leave it as experts in their respective fields. In serving their country, they are also serving themselves. In the Signal Corps, soldiers build up an invaluable asset in the form of technical ability that can be used to advantage when they return to peaceful pursuits.

Back of this expanding army of the Signal Corps men in uniform is another vast army of men in mufti who are putting their shoulders to the wheel to get the message through. In all parts of the country, wherever a Signal Corps installation is to be found, civilians are engaged in a variety of important tasks. Their work runs the gamut from office management to scientific accomplishment.

Like the Military Division of the Signal Corps, the Civilian Division is growing daily. The two work arm in arm. They step together towards a common goal. And, also like the mili-



Group of students receiving instruction on the correct use of tank sets and on voice communications.



Loading portable equipment into large transport plane. Aircraft radio is another important classroom subject.



This medium tank is used as a radio "guinea pig" by civilian students. They are removing a tank receiver.

Fish-pole antenna is about to be inserted into its special socket. Spring-insulators permit whipping.

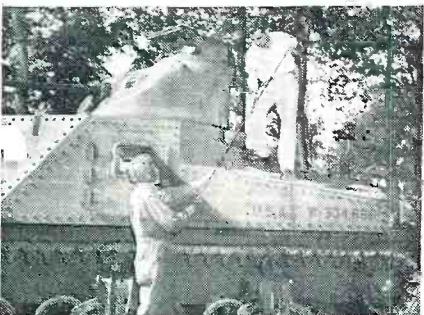

Maintenance of radio equipment is vital to the successful functioning of our mechanized field armies.

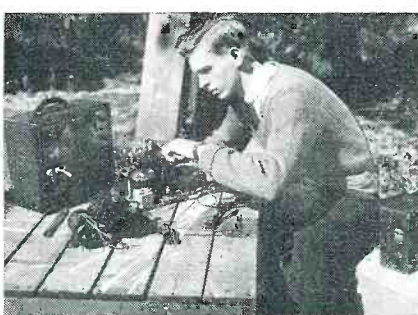

tary, there is an urgent need of qualified civilians. Technical civilian personnel in particular is required in large numbers.

Minor physical defects will not limit applicants from possible service in civilian work as long as they can do a satisfactory job and have had technical training in the field of communications such as radio, telephone or telegraph. As a matter of fact, people who wish to secure valuable technical training in any of these classifications are eligible to apply for employment.

Men who have had some previous contact with radio, for example, are usually well qualified for employment as junior repairman trainees. Men with this type of background are employed through civil service at a salary of \$1,440 a year. Initially they attend a Civilian Signal Corps Training School during which about half of their working time is spent in the classroom and the other half in shop work. Upon completion of this course, junior radio repairman trainees may be selected to attend other radio schools where further advanced technical training will be given to them. Or, they may be sent to any of the far-flung Signal Corps repair shops



Tail end of aircraft antenna. Proper splicing is of greatest importance to prevent breakage of wires.



Members of a tank maintenance crew are busily at work preparing the radio equipment for service in the field.



Inserting vertical tank antenna into its special insulator. Note tank helmet worn by student in rear.

and laboratories. In all cases advances in salary are governed by the aptitude and native ability of the student. Those who show special aptitude, will progress to advanced courses at higher rates of pay.

Men between the ages of 16 and 50 who do not have this technical training and who desire to enter the Signal Corps training program may be employed as mechanic learners. The mechanic learner course covers a period of three months, during which time the students are paid at the rate of \$1,020 a year. No previous contact with radio is required for admission to this course and graduates usually pass up to the rank of junior radio repairman trainees at the higher rate of pay.

During the first three months as a mechanic learner, the trainee receives instruction in mathematics and algebra up through elementary trigonometry and vector analysis which is sufficient to enable him to solve parallel a.c. circuit problems. In radio physics the student is taken from an introduction to the course through resonant circuits and filters, transformers, com-

*(Continued on page 58)*

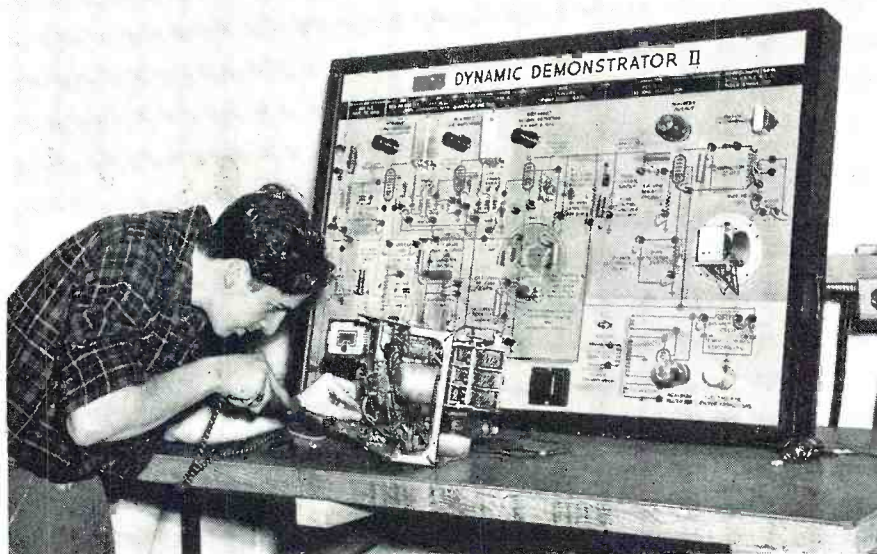

Here's our old friend "The Dynamic Demonstrator" in use in the classroom. Students soon become proficient men. Motors and generators are used in most vehicular units. Proper care is essential to most efficient field operation.





G-E plotron tube, types PJ-7 or PJ-8.

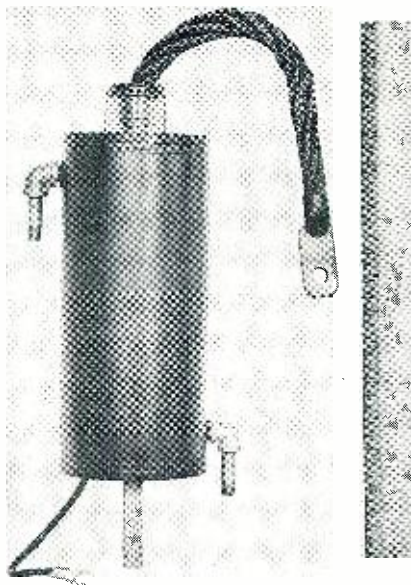

G-E ignition tube, type FG-235-A.

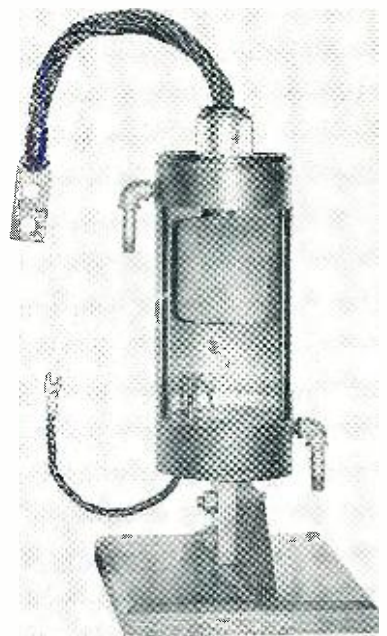

Internal structure of FG-235-A tube.

# ELECTRONIC TUBES AND THEIR APPLICATIONS

by **MARTIN E. FRANKLIN**

*Many types of gas-filled and high-vacuum tubes, now used in electronics, afford an interesting variety of new services.*

THE evolution of scores of uncanny methods of electronic control, providing an apparently endless stream of unique possibilities, has made quite a stir not only in engineering circles, but everywhere. The radio tube, as we know, was the first device that so successfully utilized the unusual properties of the electron. Today, however, we have another supply of tubes that more than capitalize on the electron and its control. We all know of the many purposes to which the X-ray and cathode ray tubes have been put in the medical, entertainment and laboratory fields. But now with the full realization of the usefulness of the electron, such tubes as the thyratron, phanotron, ignitron, and plotron, as well as the phototubes, have been rising to great power.

Most of these tubes are constructed in much the same way as the more popularly known vacuum tubes. That is, they contain a filament or indirectly heated cathode, one or more grids and a plate or anode. However,

some of these tubes contain an inert gas or vapor, such as argon, mercury, or caesium, which when ionized by a bombardment of electrons, constituting a flow of plate current, have the property due to the charge of the ions, of completely neutralizing the effect of the grids and the so called "space-charge." Actually, space-charge is an excessive accumulation of free electrons in a vacuum tube in the space just outside of the cathode.

There is a tendency of the quantity of negatively charged electrons in this space to neutralize the positive accelerating potential of the anode. This then allows more electrons to accumulate around the cathode, thus holding up the total flow of electrons, in the same way as traffic is held up in a traffic jam. In addition, the presence of comparatively heavy slow moving positive ions tends to neutralize the charge of the negative electrons and keeps them moving out of the congested area, in the same way as a traffic cop keeps traffic moving. Thus

we have a flow of electrons when ions are present, limited only by the supply of electrons or vehicles, or by the resistance in an external circuit, which can be paralleled to a narrow road at some other point. When no current flows in gas or vapor filled tubes, no ions are created. We thus can see that because of the negligible number of ions present, the grid has full control and can prevent the flow of plate current. But as soon as the grid has allowed plate current to flow, ions are created by an electron bombardment of the gas molecules. The effect of the grid is then neutralized by these ions, so that the grid loses complete control of the electron stream. And the grid will not again regain control of the electron stream until the ions have been removed by other methods.

Just what voltage drops are necessary within the tube to prompt sufficient velocity to the electrons to ionize the gas or vapor is dependent on the type of inert gas or vapor in the tube.



G-E Kenotron tube, type GL-411.

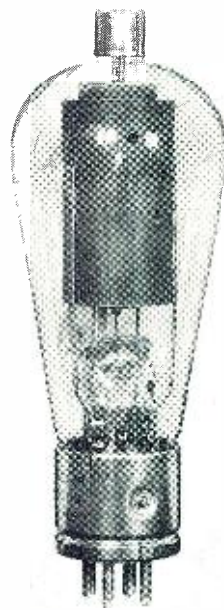

G-E Thyatron tube, type FG-17.

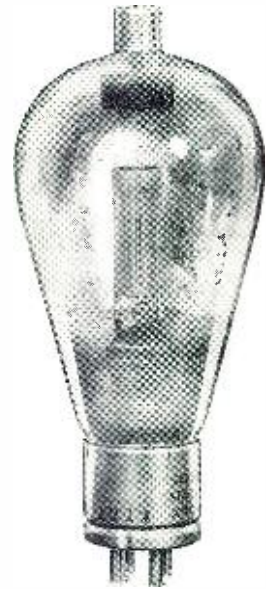

G-E Phanotron tube, type FG-32.

When the tube voltage drop is allowed to drop below this critical voltage, ions are no longer created and those present flow to the more negative elements in the tube. However, when the quantity of ions has been sufficiently reduced, the grid regains control of the electron stream.

In actual applications, either the gas or vapor filled tubes are generally used with an a.c. plate supply, so that on the reverse half of each cycle, when the plate voltage goes negative, the plate current ceases. Thus most of the ions flow from the space within the tube to the anode, cathode, or grid. In this, the grid has the power to stop or allow plate current to pass, at the beginning of each new positive half cycle.

Probably the most popular of the tubes operating in this fashion is the thyatron. This tube is adaptable to photo relay applications by wiring the drop across the phototube load resistor to influence its bias. A typical circuit using this type of tube is shown within these pages. The tubes used in these circuits are the RCA 2051 and 923 types.

In view of their unusual properties, these tubes are used for voltage control and regulation, for manual or automatic speed control where stepless accurate regulation is necessary. For example, tube control is used to correlate the speeds of various sections of rubber process conveyors to maintain a given loop of rubber sheet between conveyor sections. It is also used for varying over wide ranges, the speed of direct current motors driving frequency changes, which supply power to high speed textile motors. The use of gas-filled tubes for the proper control of power flow to resistance welders has completely changed the manufacturing processes used to fabricate high production units such as refrig-

erators, cans and many vacuum tubes.

There are seven general types of gas-filled electronic tubes. These are the phanotron, thyatron, glow tube, grid-glow tube, pool tube, grid-pool tube and the ignitron. The phanotron is a hot cathode, gas-discharge tube in which no means is provided for controlling the unidirectional current flow. The thyatron is a hot-cathode, gas-discharge tube in which one or more electrodes are employed to control electrostatically the starting of the unidirectional current flow.

The glow tube is a cold-cathode, gas-discharge tube in which one or more electrodes are used to control electrostatically the starting of the unidirectional current flow. A pool tube is a gas discharge tube with a pooltype

cathode, either liquid or solid, in which no means is provided for controlling the unidirectional flow. The grid-pool tube is a gas-discharge tube, with a pool type cathode, either liquid or solid, in which one or more electrodes are provided for controlling electrostatically the starting of the unidirectional current flow. And finally we have the ignitron, which is also a gas-discharge tube with a pool type cathode, either liquid or solid, in which an ignition electrode is used to control the starting of the unidirectional current flow in each operative cycle.

We mentioned that welding was one of the applications in which these tubes were so successfully used. The ignitron is particularly adaptable for this work, since it can pass high cur-

Extensive and well-equipped laboratory where electronic equipment is tested with exacting methods that guarantee trouble-free service.





Novel electronic clock has more than 170 tubes that count 60-cycle pulses.

rents required to develop the necessary heat with unusual effectiveness. These tubes are also adaptable for high power conversion.

An interesting application of the thyatron was recently revealed by a wire manufacturer. We all know that in wire making it is imperative that the wire to be drawn, must be drawn with constant speed and tension. Up until the development of automatic devices, using electronic control, this tedious operation was under the supervision of one or more operators. With a new electronic unit, thyatron tubes control the speed of the motor that winds the wire on its reel. If there are any variations in the speed and tension, a movable pulley is actuated vertically, moving a plunger within a solenoid coil. This coil is connected to the grids of the thyatron tube. The movement of the plunger changes the inductance of the tube grid circuit, and thus the tube output voltage is also changed. Upon the armature of the motor turning the reel this variable voltage is then applied.

A visit to the section below the huge stage of the *Radio City Music Hall* will reveal that thyatrons are used to provide thousands of combinations of colors and intensities.

To study the properties of high speed rotating or vibrating objects, elec-

tronic devices are also used. With these devices, having recurrent periodic motions, these motions may be made to appear at rest. Or they may be made to trace their prescribed course in either a forward or backward direction at any desired reduction in speed. The electronic device in this unit is the timer, which is mounted in the lamp unit. This produces accurate time impulses which cause the lamp to flash at a frequency determined by the controls. The timer in some instances consists of our friend, the screen grid amplifier tube. This tube periodically charges a condenser, which when it reaches the proper potential, causes the grid of a gas-filled timing tube to permit a discharge to pass through its plate circuit.

Thus far we have discussed gas filled tubes. Now let us look into the high vacuum tubes, such as the kenotron and pliotron. Both of these tubes are useful in radio as well as commercial applications. The kenotron is a high-vacuum tube in which no means is provided for controlling the unidirectional current flow. It consists of two electrodes, an anode and a hot cathode. Electrons emitted by the cathode are negatively charged and will flow to the anode or plate, when a positive voltage is placed on the anode. Since

this tube will conduct current only in one direction, it is particularly useful in rectifier circuits. The resulting pulsating unidirectional current is used to charge a condenser which supplies the load circuit with a nearly uniform supply of direct current. Because such a rectifier uses only one-half of the a.c. voltage supply, it is known as a half-wave rectifier.

The kenotrons have been successfully used in many unique applications, as for instance in the making of sandpaper. In this instance, the adhesive backing for the paper and the conveyor belt covered with finely divided abrasive particles are passed through two electrodes. The electrostatic field developed by the kenotrons between the backing and the belt polarizes the particles. Thus they are hurled endwise into the adhesive. The recovering of valuable particles from flue gases in smelters, sulphuric acid plants, cement mills, plants for detarring natural gases has also been activated by the use of kenotrons. In one instance, a fly-ash precipitator, the precipitators are powered by kenotrons to remove solid particles from factory smoke, which would otherwise be deposited over the surrounding country.

Another member of the high vacuum family is the pliotron. In this tube, one or more electrodes are used to control the unidirectional flow of current. Actually this tube is a kenotron with the addition of a grid or grids for control. In the kenotron rectifier, the amount of current which can be passed through the tube at a given positive plate voltage is limited by the building up of a negative space charge around the filament, caused by the electrons which are leaving it. If a positively-charged grid is now placed between the filament and the plate, this negative space charge is partially neutralized and more current can flow to the plate. And of course, if the grid is negatively charged, the current flow is decreased.

Now if the grid is made sufficiently negative, the current flow can be completely cut off. Between the cut-off value and the maximum value of grid potential, to which it is safe to go, the control of the grid over the plate current is continuous. As the grid is closer to the filament than to the plate, a given change of grid potential has a greater effect on plate current than an equal change of plate potential. Thus the pliotron can be used to amplify voltage variations.

If the variations of grid potential are maintained in the negative region, substantially no electrons can flow to the grid, so that it is possible to obtain considerable amounts of power in the plate circuit with the expenditure of very small amounts of power in the grid circuit. The pliotron can therefore be used as a very sensitive device. Since this tube can amplify power, it is possible to make it generate sustained oscillations by feeding back a

(Continued on page 79)

A Thyatron circuit using a 2051 electronic tube.

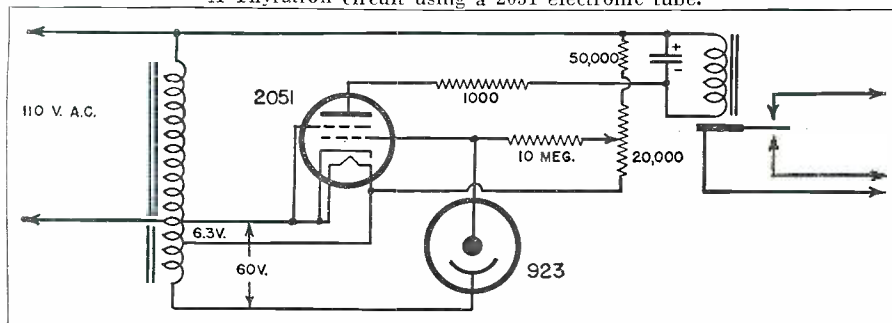



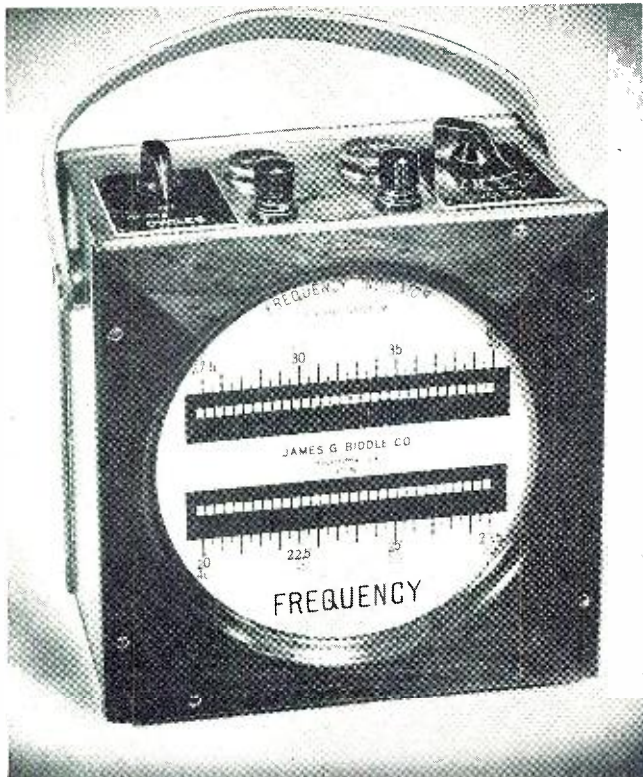

Fig. 1. Laboratory type frequency indicator.

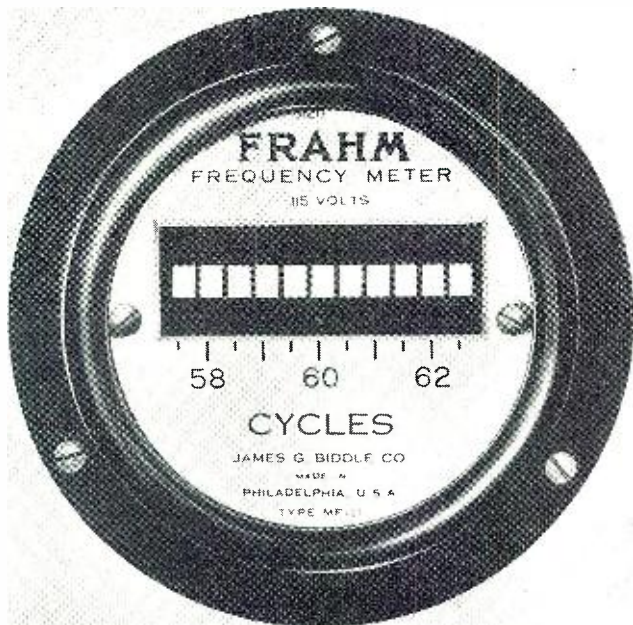

Fig. 2. Panel-mounted frequency meter.

# The Measurement of AUDIO FREQUENCIES

by **RUFUS P. TURNER**  
Consulting Engineer, RADIO NEWS

**An analysis of several means for the accurate measurement of frequencies in the audio range of from 1 to 20,000 cycles.**

THE modern engineer and experimenter have at their command - - numerous instruments and techniques for the measurement of frequencies between 1 and 20,000 cycles per second. In this range, commonly referred to as the audio-frequency spectrum, lie the frequencies employed in commercial a.c. power transmission; the entire band employed in radio and telephonic transmission of speech, music, and tone signals; and the lower supersonic frequencies employed for some forms of carrier-current communication and control and in certain research.

In this article, we propose to explain several of the instruments, circuits, and methods used for the measurement of audio frequencies. Our purpose has been to select those systems which, by virtue of long service and continued dependability, have be-

come standard in the field. Some attention has been devoted to the chronology of development.

The reader will easily discover for

Fig. 3.

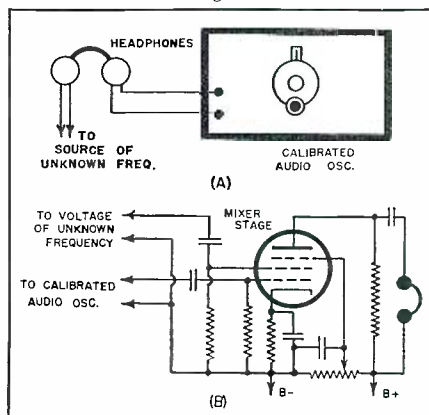

himself that some of the methods are more adaptable to one particular application than to another, while others are more universal. Likewise, some are indispensable for a single application. It is believed, therefore, that this review of the art will enable the electronicist and the research worker to select the most satisfactory audio-frequency measuring method for his instant requirement.

Instruments and methods have been classified as follows:

1. Direct Comparison of Freq.
  - a. Aural
  - b. Meter or Electric Eye Indicator
  - c. Oscilloscope
2. Audio-Frequency Bridge
3. Indicating Frequency Meters
  - a. Movable-Iron Type
  - b. Vibrating-Reed Type
  - c. Electronic Type

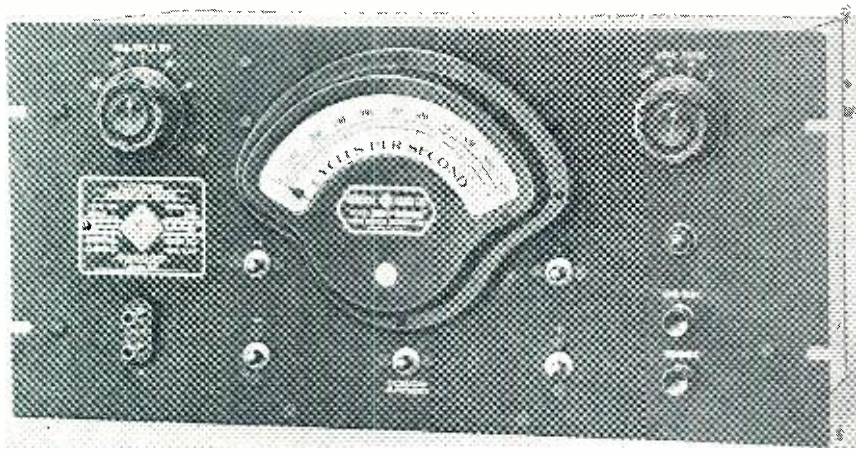

Fig. 5. Precision panel-mounted electronic frequency meter.

### Measurement by Direct Comparison

An unknown audio frequency may be identified by direct comparison with a known audio frequency, utilizing the ear or a suitable indicating instrument to show synchronism between the two. This is perhaps the most widely used of the simpler methods.

Figure 3 shows connections for comparison by ear. In scheme A, the headphones are connected directly to the two audio sources, or through suitable potentiometers if the audio voltages are too high for the headphones. The unknown frequency is fed into one ear-piece; the known or standard frequency into the other. The standard frequency is best supplied by a calibrated variable-frequency audio oscillator of either the beat-frequency or resistance-tuned type.

The ear will detect a beat note between the two voltages except when

the frequencies are exactly equal. The beat note takes the form of a waxing and waning when the two frequencies are close in value and appears as a flutter at higher frequency differences—the speed of the flutter in-

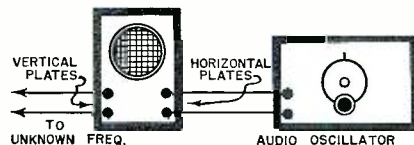
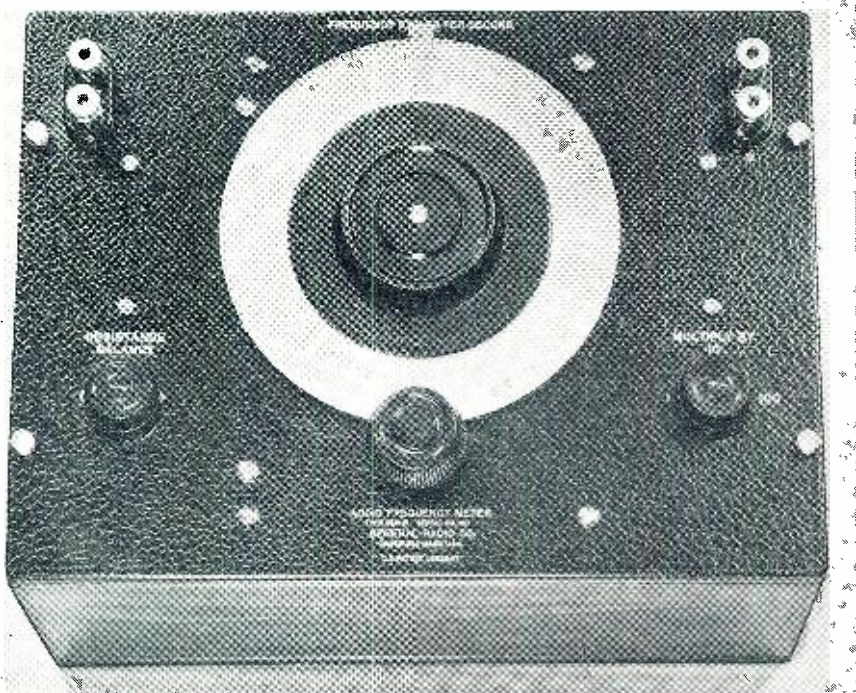

Fig. 4.

creasing as the difference increases.

Scheme B shows a variation of the method in which a vacuum tube mixer stage is employed to combine the two audio frequencies and the headphone detector is connected in the plate output circuit. This stage is referred to as a mixer, monitor, or mixer-monitor, and is preferred in some laboratories.

Fig. 6. Portable laboratory frequency meter—20 to 20,000 cycles.



The mixer is kept permanently set up and may be used for closely-separated radio frequencies as well as audio frequencies.

With either scheme, when the standard oscillator is adjusted to the exact frequency of the unknown, there will be no interference between the two signals and the reinforced single frequency signal in the headphones will be clean and clear. At this point, the value of the unknown frequency may be read directly on the dial of the audio oscillator.

An instrument may be employed instead of the ear. If an indicating a.c. voltmeter with fast d'Arsonval movement is used, the pointer will vibrate about a mean value of output voltage under influence of the beat note, swinging slowly back and forth for low values of frequency difference and vibrating rapidly for higher values. This motion occurs symmetrically on both sides of "zero beat," the latter (exact frequency condition) being denoted by a stationary reading of the meter.

A frequency difference of a single cycle per second may be detected with a fast meter or magic-eye indicator. The accuracy of adjustment by the ear method, on the other hand, will be governed entirely by the operator's skill in recognizing exact audio zero beat. Because of the physiological limitation, the ear method is used only where approximate results are satisfactory.

Figure 4 shows the most satisfactory method of identifying audio frequencies by direct comparison with a standard. This method is in use in the best laboratories.

Here, a cathode ray oscilloscope is employed as the indicator and its operation as such is very precise. In use, the internal sweep oscillator and internal sync of the oscilloscope are switched off. The "unknown" audio-frequency source is connected to the amplified-vertical input, and the calibrated v.f. audio oscillator to the amplified-horizontal input.

As the oscillator is tuned through its range, a succession of complex patterns, Lissajou's Figures, will appear on the oscilloscope screen. When the oscillator is set exactly to the unknown frequency and the two frequencies are near phase quadrature (90°) the pattern becomes a circle or ellipse which stands still on the screen. If the oscillator frequency is slightly higher than the unknown, the circle will revolve slowly in the vertical plane from left to right. If it is slightly lower, the circle will revolve slowly from right to left. At exact "resonance," the pattern is perfectly stationary and the frequency of the unknown may be read directly on the audio oscillator dial.

When the oscilloscope is used in the manner described above, direct comparisons of frequency may be made with high accuracy of setting. No error is introduced by the method of determining synchronism. The accuracy of



Fig. 7. Another type of frequency meter—used with external box.

frequency measurement by this method is accordingly governed entirely by the accuracy of calibration of the audio oscillator and the latter's stability.

#### Audio-Frequency Bridge

Audio frequencies may readily be identified by means of a suitable a.f. bridge. This is made possible by the fact that, with a given set of bridge components, null will be obtained at a different setting of the variable arm for each value of bridge-voltage frequency.

Best all-around facility in frequency measurement is afforded by the bridge shown in Figure 8. In this circuit,  $R_2$  is made twice the ohmic size of  $R_1$ , and these resistors form the ratio

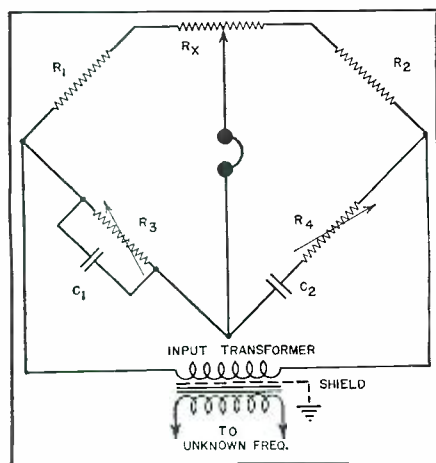

Fig. 8.

arms. For any setting,  $C_1$  equals  $C_2$ , and  $R_3$  equals  $R_4$ . The latter two resistors may thus be the separate arms of a dual rheostat, since at all settings they will be equal to each other. The

small auxiliary balance potentiometer,  $R_x$ , compensates for any discrepancy in tracking between  $R_3$  and  $R_4$  when these resistors are the arms of a dual rheostat, and thus enables the operator to obtain a clearer null adjustment.

The voltage of unknown frequency is applied to the terminals of the input transformer through which it is coupled to the bridge. The dual resistor,  $R_2$ - $R_1$ , is then adjusted for null, if necessary with the aid of  $R_x$ . This null will occur at only one setting for each fundamental frequency. At null, the frequency of the applied voltage is equal  $1/6.28 RC$ ; where  $R$  is expressed in ohms and  $C$  in farads.

Although headphones are shown as the null detector and will be satisfactory for approximate results, a vacuum-tube voltmeter will give sharper null indications when greater precision is required. For increased sensitivity and still greater precision, an amplifier may be employed ahead of the null detector.

Figure 6 shows a commercial version of the bridge-type audio-frequency meter. The main dial, which controls the dual resistor, is graduated directly in cycles per second. The instrument covers the range 20 to 20,000 cycles per second in three steps: 20-200 c. p. s., 200-2,000 c. p. s., and 2,000-20,000 c. p. s. The accuracy of indications is 0.5% for the entire range of the instrument.

The bridge-type audio-frequency meter offers the advantages that it is compact in size, no tubes or batteries are required for its direct operation, frequencies may be read directly from its single tuning dial, and it is practically fool-proof in operation. With reasonable care, its accuracy of calibration and setting may be maintained.

Low frequencies, particularly those employed in commercial electric power transmission, are frequently read directly by means of movable-iron-type meters which may be either switchboard or portable in model. An example of the movable-iron instrument is shown in Figure 7 and its basic circuit in Figure 9.

#### Movable-Iron-Type Frequency Meter

Referring to Figure 9, two stationary coils,  $L_1$  and  $L_2$ , are arranged in the movable-iron-type frequency meter at right angles to each other. The movable element is the long, narrow soft iron vane,  $V$ , with attached pointer to indicate direction of the resultant magnetic field set up by  $L_1$  and  $L_2$ . The resistance-inductance network connected to the stationary coils reduces the phase difference between currents flowing in these coils and thereby prevents the iron vane from rotating. Rotation of the magnetic field is now no longer uniform, but irregular; and the vane, because of its inertia, cannot follow this field. As a result, it assumes a position proportional to the frequency of the current.

This type of instrument which is to be seen chiefly on the switchboards of electric power stations, is generally supplied for power-line frequencies—25, 40, 50, 60, and 125 cycles per second. However, they have occasionally been manufactured for use at frequen-

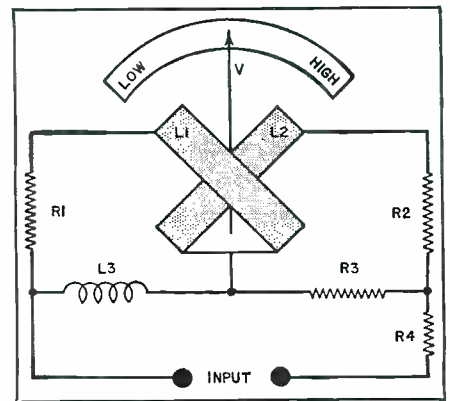

Fig. 9.

cies as high as 500 cycles. The normal operating frequency for which the meter is intended generally appears at the center of the instrument scale, with an equal number of cycles above and below this frequency. The full-scale frequency range is usually 30% of the mid-scale frequency value.

Movable-iron frequency meters are supplied for single-frequency, single voltage; single frequency, double voltage; or double frequency, single voltage operation. Typical accuracy is 0.5% of the indicated frequency. Typical operating voltage ranges are 100-125 v. and 125-150 v. Higher-voltage operation, such as at 220-250 v. or 250-300 v., requires the use of a potential transformer.

The movable-iron frequency meter  
(Continued on page 75)



I. E. Mourontseff, Westinghouse Engineer, making adjustments in the "Klystron," a new tube to transmit power through space.

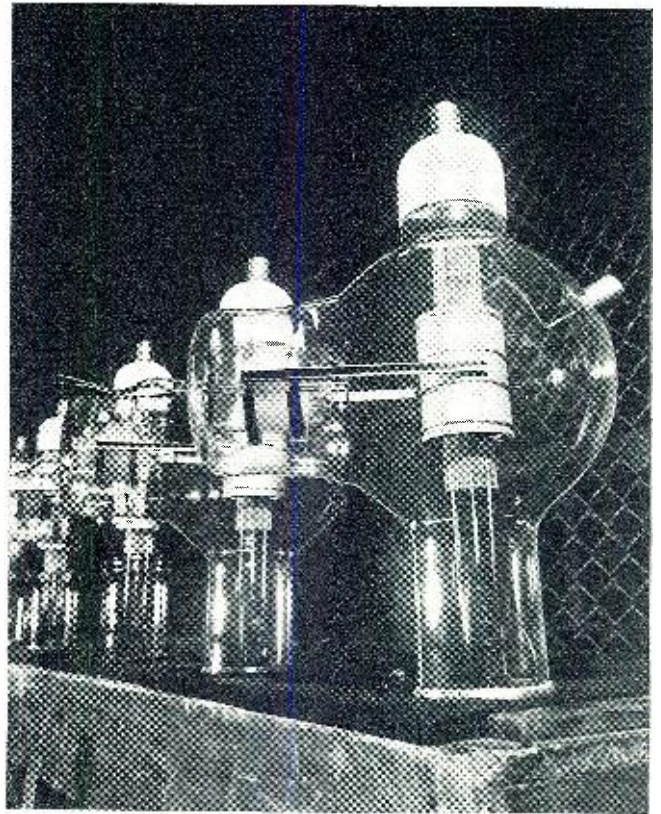

These "Sentinels of Communications" are ready for U. S. Navy. They are 100 watt screen-grid, air-cooled tubes.

# WARTIME PROGRESS IN ELECTRONICS

by **ROBERT EICHBERG**

*The author presents a very complete discussion of the tremendous rate of development on subjects of little-known units.*

**R**ADIO, as we know it today, was born of World War I. An experimenter was broadcasting music for test purposes shortly after the armistice, and a Pittsburgh department store, with a large stock of Army surplus sets, advertised that purchasers could "Hear Dr. Frank Conrad's stations." Such was broadcasting's humble beginning.

Many people, reading the Government order freezing radio receiver manufacturing shortly after the attack on Pearl Harbor, thought that technical progress in radio would be suspended in the United States for the duration of World War II, save perhaps for military purposes.

It is true that much of the best en-

gincering effort is being devoted to military radio—and with some remarkable results. Nothing of this nature will be described in the present series of articles, for two reasons: (1) America's war effort is best served by maintaining absolute silence on the amazing devices which are now being used, and others which will soon be used to make American skies death-traps for enemy planes; and (2) there is still considerable activity in commercial radio design—the field which will be of most financial interest to RADIO NEWS readers when the war is over.

Examined by the cold eye of the scientist, war affords humanity one benefit: it speeds up technical prog-

ress. Though they existed prior to World War I, both radio and aviation emerged from the laboratory to become everyday utilities under the spur of military need. Now there are indications that wireless transmission of power, of which Dr. Nikola Tesla talked and dreamed—and on which he worked with some success—twenty-five years ago, may cease to be a chimera and become an actuality, bringing light and electric power into rural areas too sparsely populated to make the running of power lines economically possible.

The Klystron, a high-frequency power tube which first came to the public notice a year or two ago, is beginning to grow up. At about the

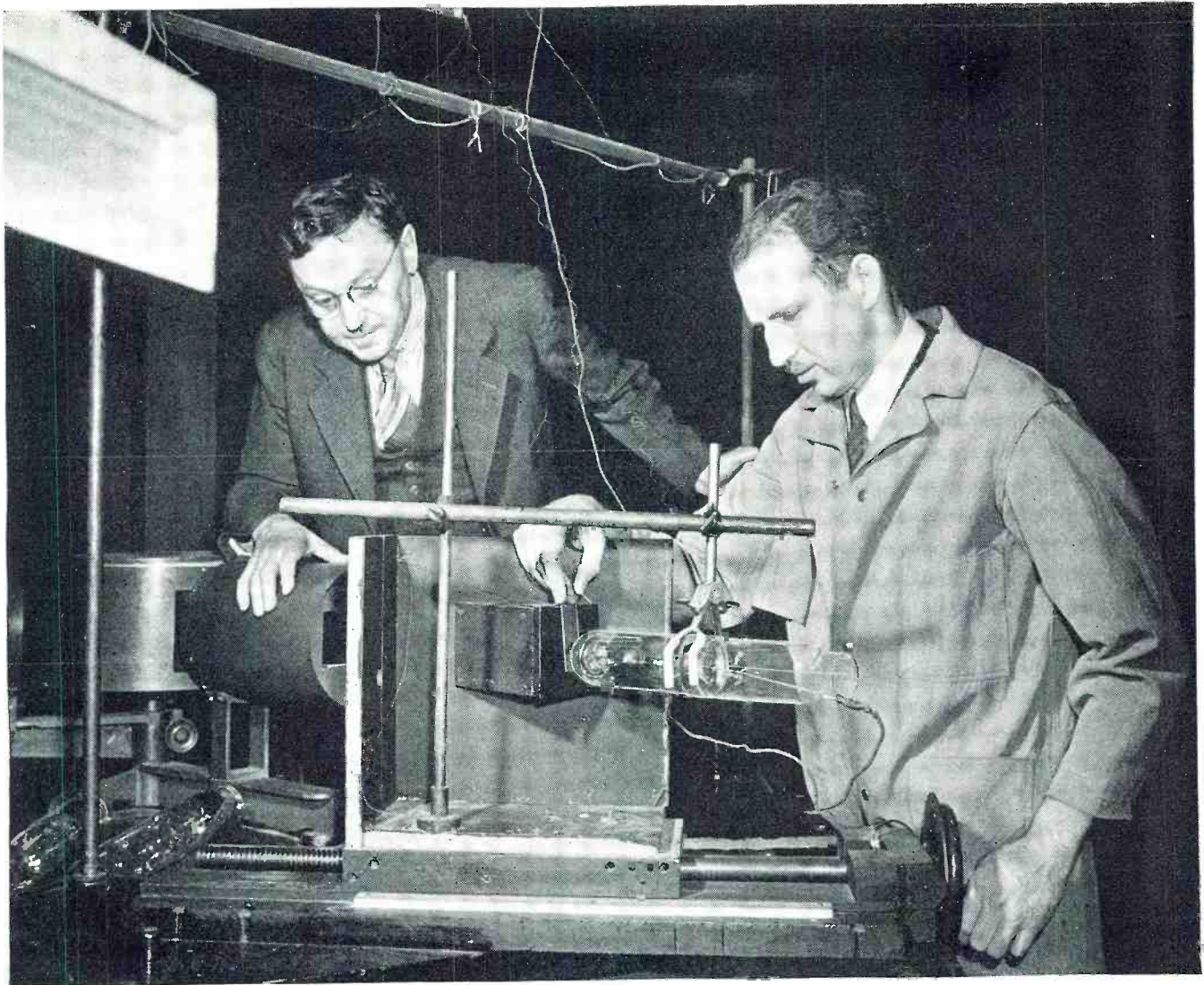

An electronic instrument which will soon make possible daily measurements of the nation's "sunfall" by rays.

same time, a series of experiments was described; these dealt with the use of parabolic reflectors and those of other shapes to direct radio waves over extremely narrow paths. As the wave is not allowed to radiate in all directions, a large part of the transmitted energy actually reaches the point to which it is "aimed," and little of the energy "misses" the receiving antenna. This principle has now been applied to the Klystron, and at a conference of university deans and professors held in the *Westinghouse Lamp Laboratories*, Bloomfield, N. J., late this autumn, the combination of Klystron and copper-lined, trumpet-shaped antenna was used to light electric bulbs some distance away. According to authoritative engineers, further development may result in the commercial application of such wireless power transmission.

Incidentally, there have recently been some stock promoters attempting to capitalize on the perfectly legitimate developments, such as are described above. It is the practice of these shady gentry to hire a vacant store and to suspend in the window

an electric light bulb to which a small closed loop is attached. Even the skeptical onlookers were convinced that there was no concealed wiring when a demonstrator removed the bulb from its suspending cords, and it continued to glow. But members of the audience who had any familiarity with radio chuckled; they knew that the power came from a coil concealed a short distance from the bulb and acted as the primary of a transformer, of which the coil fastened to the bulb served as a secondary.

Almost as simple, but of real value is a minor circuit change designed by Mr. Wen-Yuan Pan, A.I.R.E., who works for *China Defense Supplies*, Washington, D. C., and *Universal Trading Corp.*, New York, N. Y. His invention deals with a means of eliminating the low frequency regeneration which causes motor-boating and other undesirable noises in high gain multi-stage amplifiers.

This feed-back, Mr. Wen-Yuan reasoned, is due to the impedance of the power supply being common to several stages, thus causing regeneration from the high level stages to the plate

of the first stage. In his description of the problem and his solution, which appeared in the *Proceedings of the Institute of Radio Engineers*, he points out that the usual method of combatting this effect—the use of a resistance-capacity filter to attain decoupling—is not particularly effective at the very low frequencies which persistently cause trouble. He prefers to use a neutralizing method, in the interest of efficiency and economy.

Mr. Wen-Yuan's solution, as he states in his article in *Proceedings*, is a cheap way of eliminating all regeneration at all frequencies. An inspection of his drawing reveals that the circuit is standard, save for the addition of a special capacitor. As the inventor explains in his paper, this capacitor (by correct adjustment of grid and cathode constants of the second stage) produces a voltage,  $E_1$ , across the cathode resistor of this stage to balance out the voltage  $E_2$ , which the voltage across the common plate impedance,  $Z$ , has caused to appear on the grid of this same tube.

Though four formulae are given in  
(Continued on page 70)

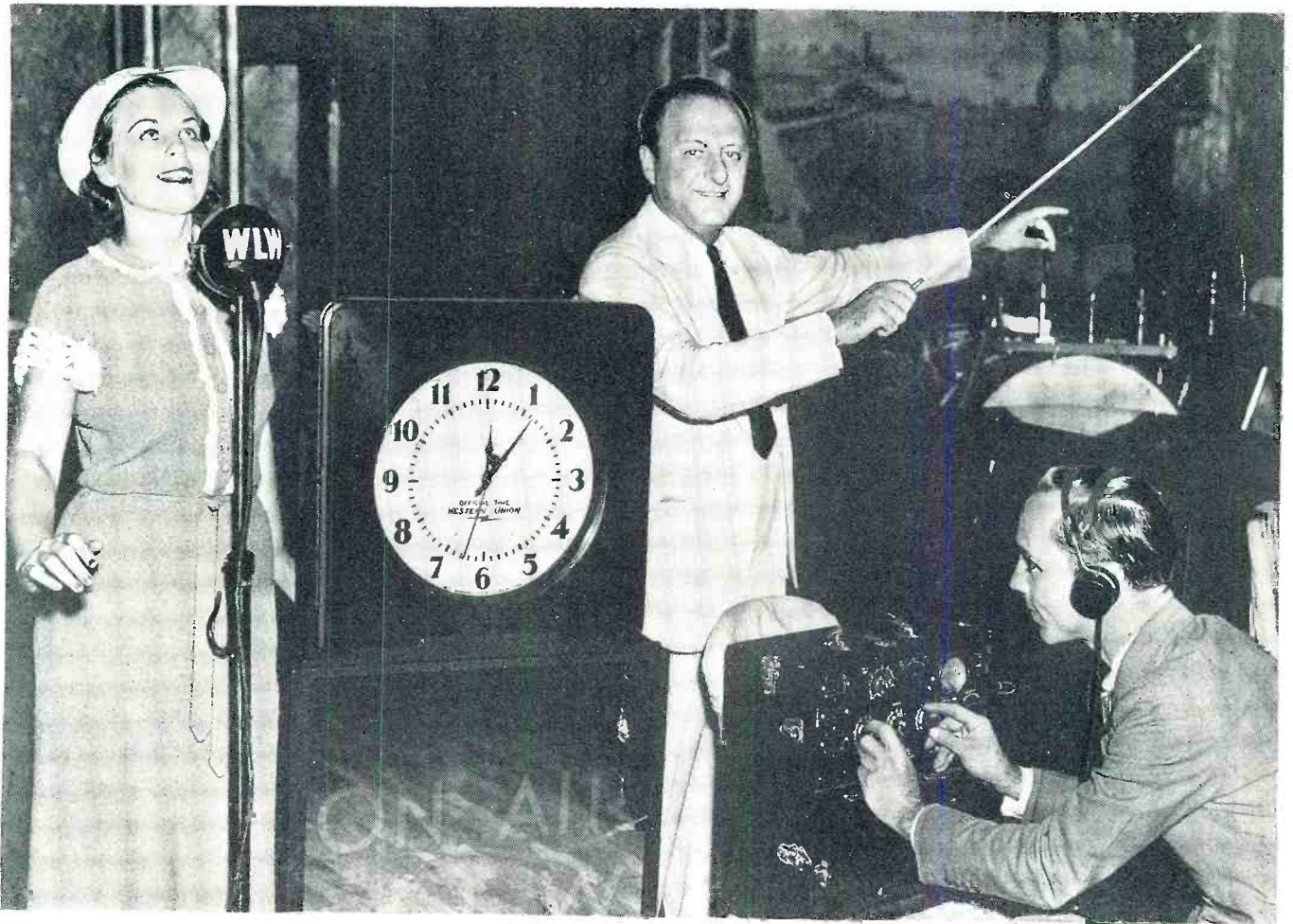

About 70% of U. S. Broadcast stations use Western Union Time clocks.

# ★ ELECTRONIC TIME ★

by **GUY DEXTER**  
Electronic Consultant

*This interesting analysis reveals the all-important electronic function of the modern technique in computing accurate time.*

**S**TANDARD time is of vast radio and electronic importance. Dozens of formulae whereby we calculate the size of components or predict circuit performance contain the factor *t*.

The history of time telling is a long story of watching the sun, of sand and water glasses and marked candles, of clocks propelled by all manner of physical forces, and of the present-day highly-refined electrical gear which is complex beyond the understanding of the most celebrated early clock makers. It is impossible to tell the whole

of that remarkable story on these pages.

Man learned to measure the hours early in his history. The earliest ancestor of the modern minute counter was probably the first primitive man to recognize the rising and setting of the sun as the markers of a single day. His more thoroughgoing followers undertook to subdivide the interval between dawn and dusk into hours.

The highly accurate modern systems for determining correct time are indispensable to life today. Science, industry, and personal affairs depend

upon time. Standard time is the yardstick whereby many other dimensions in the physical universe are reckoned—speed is expressed as so many miles *per hour*; the frequency of radio waves, a certain number of kilocycles *per second*; electric power is sold on a basis of *watt-hours* consumed, and so on. In highly accurate surveying and map-making, standard time signals as a calibration source are employed in the determination of longitude. Likewise, in gravity determinations, in the location of minerals and oil, and in the measurement of radio

broadcast transmitter frequencies by the government monitoring stations these signals are employed for standardization. They are used also by seismologists who coordinate earthquake records.

Our modern time-telling instruments have come from a polyglot army of workers, so to speak. Electrical and mechanical engineers, advanced opticians, and electrochemists are only a few of the technicians working in unrelated fields who have pooled their genius with the astronomer to devise more precise and efficient means for determining and distributing the correct time.

#### **Time Standardization**

Because correct time is so important, it is necessary that there be universal agreement as to the length of a single second and the number of seconds that constitute a minute or an hour. If a minute were longer or shorter in America than in Europe or Asia, there would ensue universal confusion in public and private affairs, and havoc would be played with intra-national intercourse. The present world-wide agreement as to the length of a single second has come to us from many decades of investigation, standardization, and agreement.

There has had to be universal agreement also as to the manner in which standard time is determined. The primary standard of time is the mean rotational period of the earth. We have mentioned before that observing the movement of the sun from east to west was the earliest agreed method; and, even today, determination of the hour by this method is the basis of the layman's simple observations. All time telling is based upon the earth's rotation about its axis. The rising and setting of the sun simply verifies that rotation.

Modern time-telling technique, however, enlists the aid of heavenly bodies other than the sun. But the average man understands only slightly why astronomers sight stars to determine the rotational period of the earth instead of measuring the time interval between two successive appearances of the sun at a given point in the heavens.

The explanation is that star sighting has been adopted because observations of the sun do not give accurate results. The earth must rotate through *more* than one complete revolution before the sun is seen again at the same point in the sky, this being due to the earth's orbital motion—the year-long journey of the earth around the sun. On the earth's equator, the result obtained by making observations on the sun would be four minutes longer than if observations were made on a very distant star.

The earth's orbital motion, more rapid in winter than in summer because of the elliptical shape of the path, is taking place concurrently with the earth's revolution about its own axis, and makes the sun appear to move slowly eastward among the stars

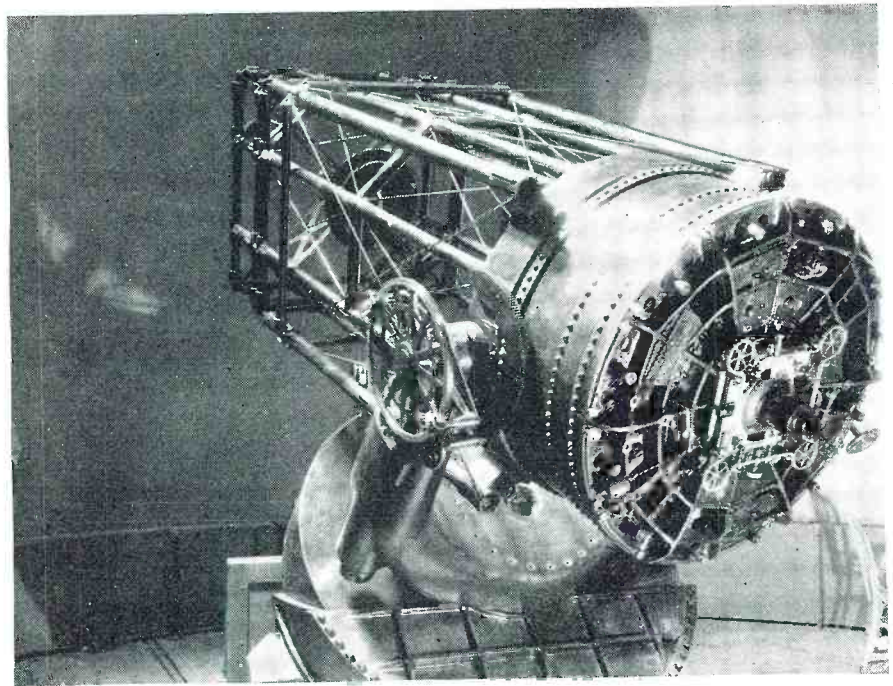

40" Ritchey-Chretien Aplanatic Equatorial Reflecting Telescope at the U. S. Naval Observatory, used visually and photographically.

Photographic zenith tube used for determining time and latitude. Full temperature and humidity control are maintained at all times.

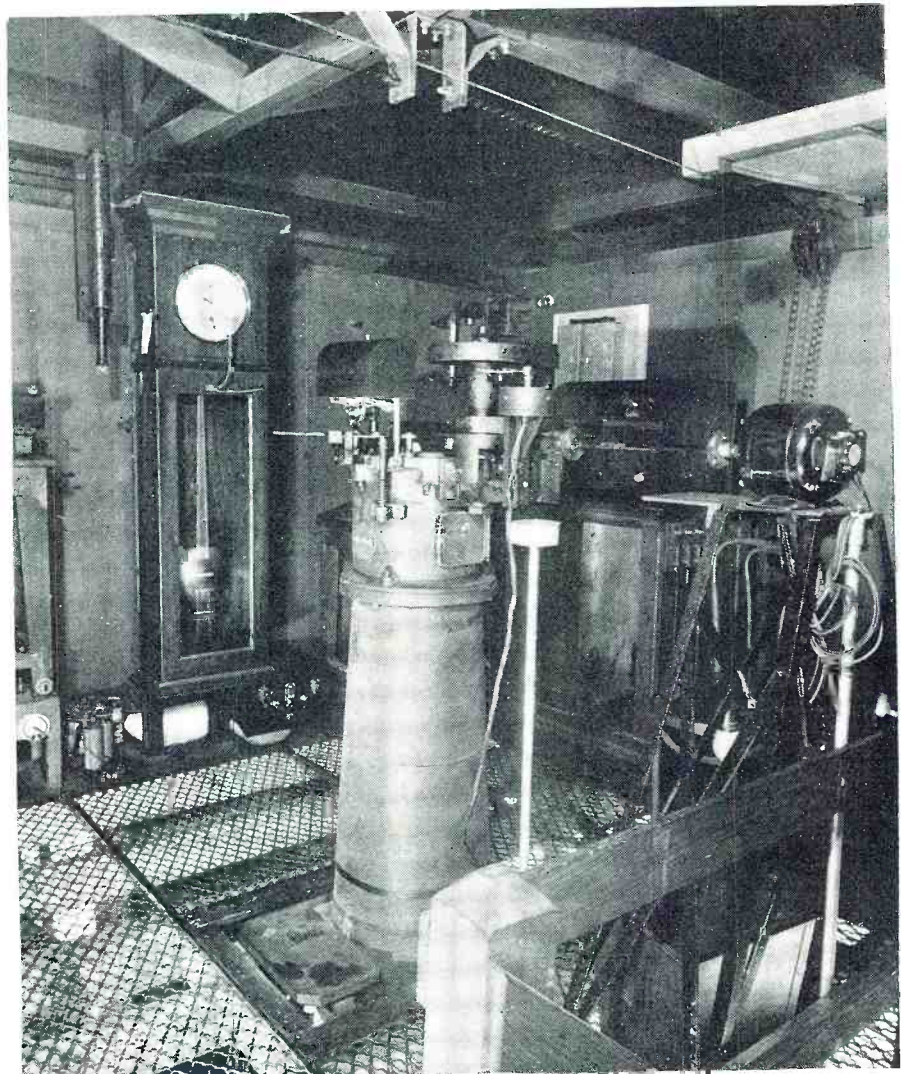

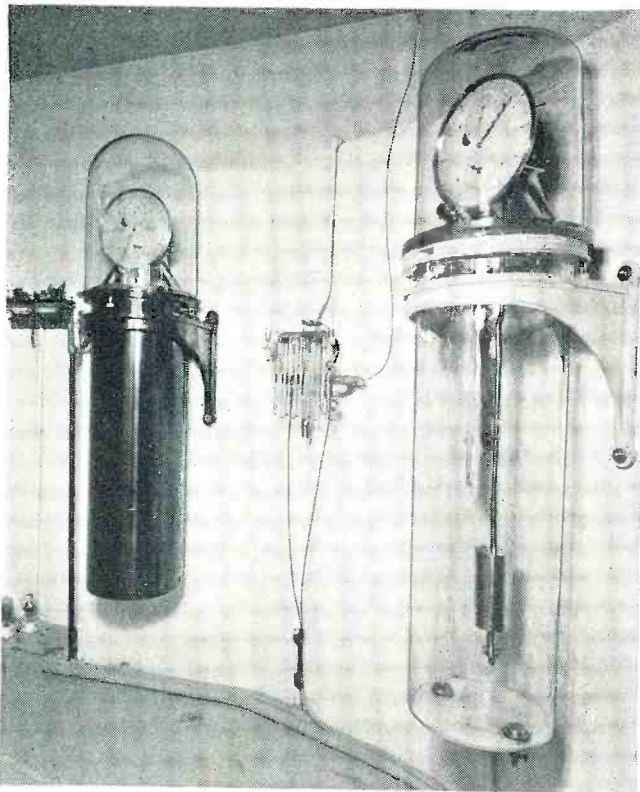

These are standard clocks for radio and electronic time. They are never re-set or otherwise disturbed unless for repairing.

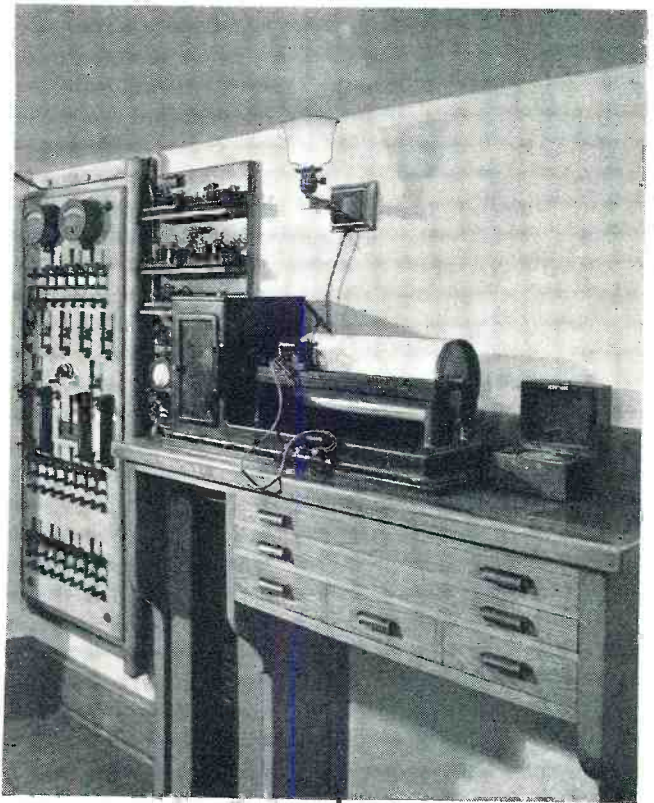

This is the Chronograph and other associated equipment at the world-famous Elgin Observatory. Note switch panel, etc.

The Elgin Observatory buildings. Note the antennae of radio stations W9XAM and W9XAN in the background.

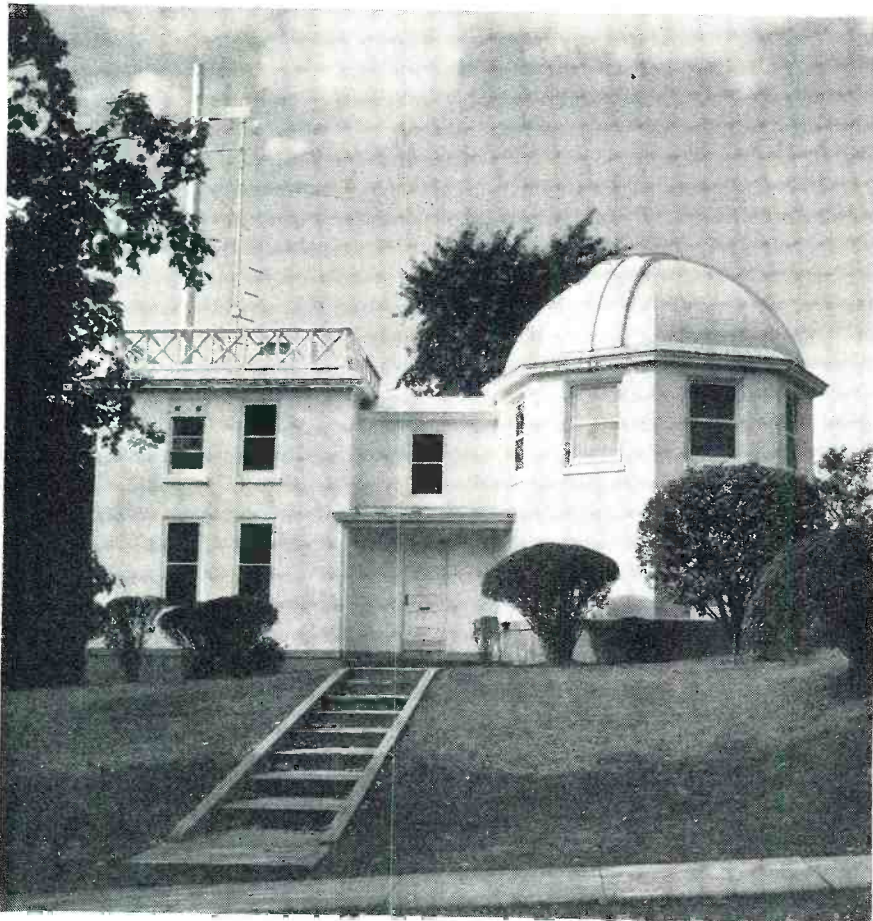

during the course of a day. Because of the earth's orbital motion, the sun would accordingly appear to rise and set once during the year if the earth did not rotate upon its axis.

#### ***Time from the Stars***

The stars, unlike the sun, being more than a million miles more distant than the sun, their apparent positions are only slightly affected by the orbital motion of the earth. The effect is the same as the illusion when objects are sighted from a moving car. Those nearby apparently rush backward, while those a little farther away pass backward less rapidly. Objects at some distance seem to travel along with the car. The distant stars are therefore more reliable for time observations.

The moment of apparent solar noon might be ascertained without further calculation simply by observing the instant at which the sun crosses the meridian (the highest point in the heavens attained by the sun). However, the size of the sun's disc and the unsteadiness of the noon atmosphere reduce the precision of this observation. And since it is possible to sight many stars during one night, increased accuracy is possible with stellar observations.

If it is noted at what time a given star crosses a north-south line or "meridian" directly overhead on two successive evenings, the time interval between the two instants of passage will be the exact period of time required for one complete revolution of the earth and is called a *sidereal* day.

The U. S. Nautical Almanac, pub-





Master clock in concrete vault in the Western Union Building in New York City is precision-regulated.

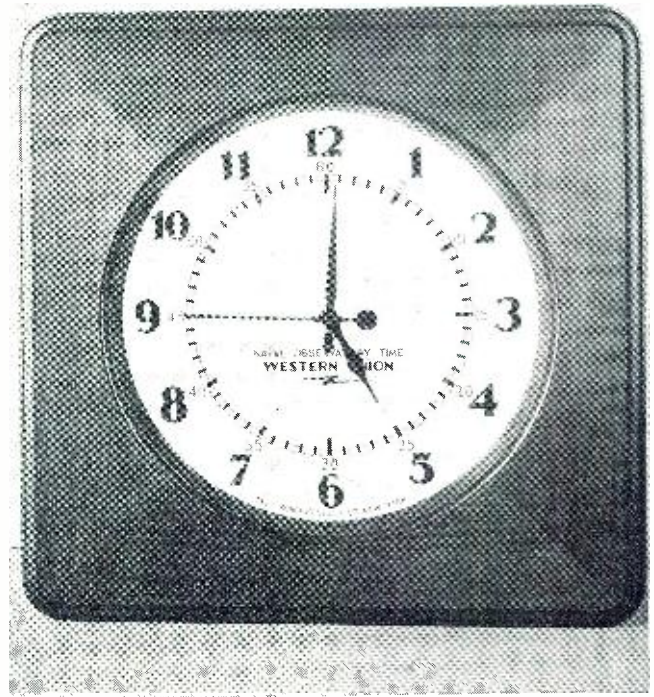

This sweep-second clock was introduced in 1936. It is now in use in over 300 radio stations in the U. S.

lished annually by the Naval Observatory, lists some eight hundred stars and predicts the exact time at which they will cross the meridian. If it is noticed at what time, according to the observer's clock, one of these selected stars crosses the meridian, the error of the clock will be the difference between the time indicated by the clock and the time predicted by the Almanac.

The sidereal day, which is often more appropriately called the *apparent equinoctial day*, is the period of the earth's rotation measured with respect to the vernal equinox (an imaginary point in the sky at the intersection of the ecliptic and the

celestial equator) from which the apparent positions of the stars are commonly reckoned. In order to render stellar observations useful, the positions of the stars in the sky, measured from the vernal equinox, must be known. The sun is at the vernal equinox at the beginning of Spring when it passes the earth's equator on its northward journey.

An *apparent solar day* is the period of earthly rotation measured with respect to the sun. The relative positions of the sun and the earth fix the positions of the vernal equinox, and solar observations are therefore a necessary adjunct to stellar observations.

The sidereal and apparent solar days

are of variable length because of the non-uniform speed with which both the sun and the vernal equinox move among the stars. *Mean time* has been devised in order to overcome this objection. The Naval Observatory says "Mean solar time is generally used for ordinary purposes, and though on an average this is identical with apparent solar time, it sometimes leads, sometimes lags behind the latter. The maximum difference between these two kinds of time (the 'equation of time') is a little over sixteen minutes."

The differences between mean equinoctial time (*uniform sidereal time*)

(Continued on page 66)

The U. S. Naval Observatory, Washington, D. C. This landmark is known as the citadel of standard time.

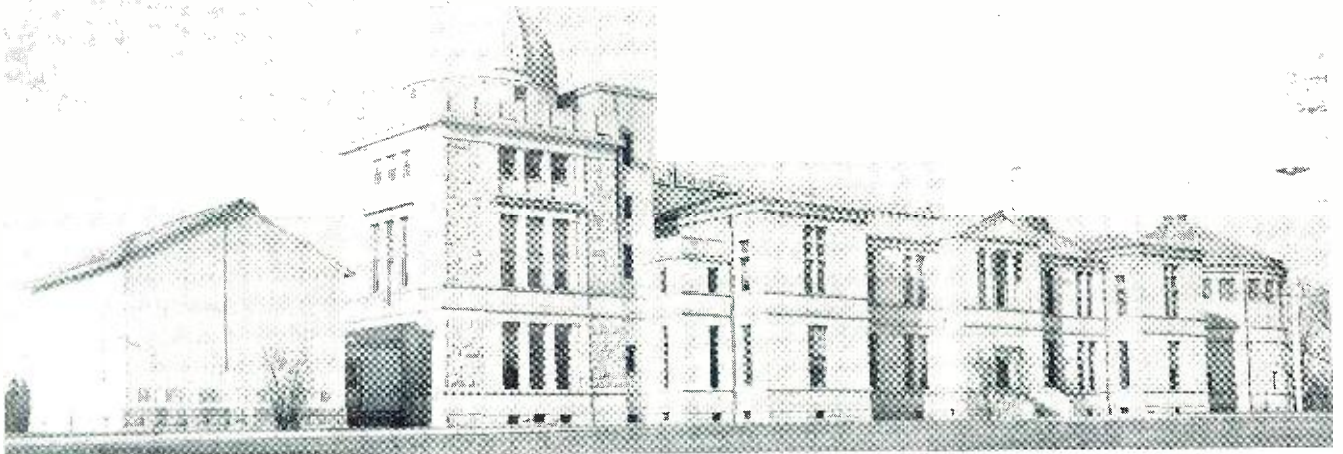



Operating position of portable. It has a husky signal—even when used with short vertical antennae.

# 112-120 MC Emergency Portable

by **OLIVER READ**

Managing Editor, RADIO NEWS

*Designed many months ago—this portable includes many desirable features for fixed or emergency networks*

THE original specifications of the portable transmitter-receiver to be described were laid out about the same time that amateurs were ordered to suspend operations. Many letters from those engaged in W.E.R.S. defense operations have requested publication of a unit which would have adequate power for reliable coverage on the 2½-meter amateur band which could be operated, either from a central point, from an automobile or from a field or emergency position where power sources were not available but where it would be possible to utilize any automobile type storage battery.

In answer to these requests, we present herewith an ultra compact and highly efficient unit which will fulfill those requirements to the letter. Several refinements have been added to increase the effectiveness of the unit, and are incorporated in the model shown.

#### **Transmitter**

It was decided originally to provide a minimum of 10 watts power in the oscillator section. The use of a HY-75 UHF triode is employed. Its remarkable efficiency at these frequencies is well known, and many amateurs already possess this particular

tube. The transmitter consists of the HY-75 modulated oscillator, 6C5 speech amplifier, and a 6V6GT or 6V6 modulator. The use of the 6V6 (GT) will permit a more compact assembly.

Considerable experience with UHF gear led to the adoption of a separate transmitter section, and if care is exercised it is possible to maintain a compact layout in spite of the necessity for separate receiver parts. The use of transceivers is to be discouraged. They are known for their faulty operation and their nasty habit of producing "birdies," which will normally interfere with nearby receivers.

Combination circuits have been used where practicable, in order to further conserve space. For example, the center-tapped choke, T5, has been used instead of the conventional output or modulation transformer. This makes for easy circuit layout and allows a compact choke to be employed.

The circuit employed for the HY-75 oscillator stage is entirely conventional. Standard parts are used throughout. The inductor, T3, is made of heavy copper or tinned copper wire, for its rigidity. Many UHF transmitters are unstable in operation when subjected to vibration where the constructor has failed to employ such a coil, and has used a lighter gauge wire. The primary link is shown on the schematic wiring diagram. Later experiments showed that even better efficiency with the antenna used could be had by using condenser-coupling to the vertical rod. This is shown clearly in the bottom illustration.

The collapsible and removable antenna is set to approximately 48" for initial adjustments. Proper loading has been accomplished when the plate current, M, reads approximately 50-60 ma. The unloaded plate current should be approximately 20-30 ma., depending upon the plate voltage used. The range of the transmitter is from 112-120 mc., and complete tuning of this spectrum is had over approximately 80 divisions on the tuning dial. The transmitter should be adjusted with an accurate UHF wavemeter or other similar equipment, and for W.E.R.S. work usually is set to a specified frequency. The ARRL has already recommended certain frequencies to be used in various parts of the country.

*Caution: Do not attempt to operate this transmitter unless you are a participant in local W.E.R.S. networks, having a special license for operation. Don't, under any condition, attempt to tune the transmitter with antenna connected as it will produce a very husky signal, and this may lead to serious consequences.*

The transformer, T4, is designed with two primaries, one of low-impedance for the microphone, the other of high-impedance for the audio output of the receiver. Two separate volume controls are provided—R8 and R9. This permits accurate setting of the modulation level, so that during transmission, the operator will always return automatically to this level, even though during reception he has varied the gain of the amplifier tube. It might be well to remove the knob on the transmitter gain control after proper adjustment has been made. This will offset the tendency for the operator to turn the wrong knob.

Sufficient output is provided from the 6C5 through condenser C14 to give a strong signal in the handset used with the equipment. A three-way jack, J1, was designed for use with a combination transmitter receiver handset. The resistor, R15, and condenser, C11, form a filter network and



The complete transmitter and receiver is housed in a 6"x6"x9" metal cabinet. Motor generator is included.

Compact arrangement of transmitter parts is shown. Note filter components mounted by the Genemotor.

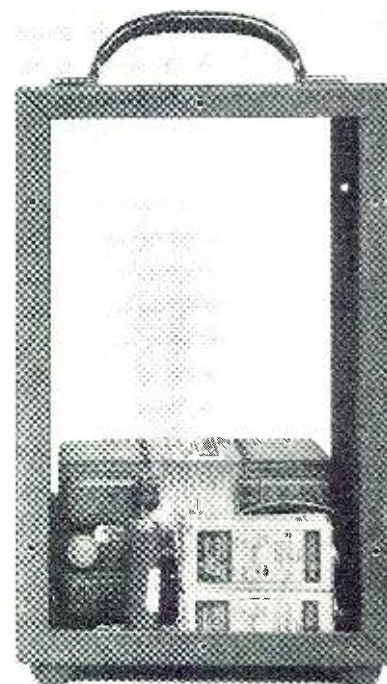
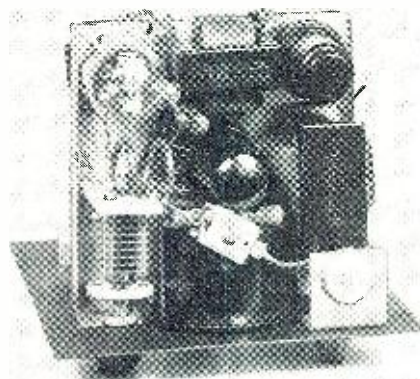

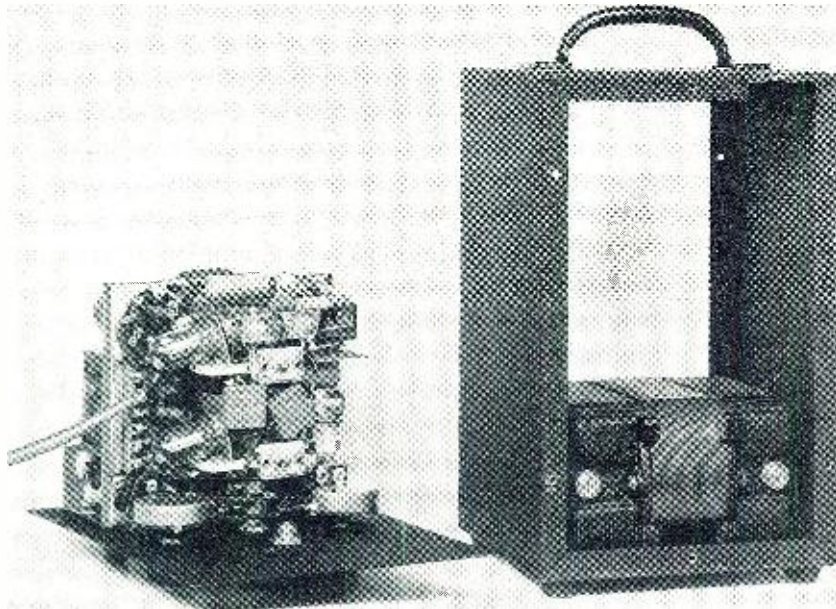

Bottom view of receiver section. Tuner parts mount on sub-panel.

also reduce the voltage from the 6-volt supply to the microphone for proper operation. Condenser, C11, serves to block out any audio frequency from feeding back to the plates of the other tubes.

A 4-pole, 2-position switch, Sw1, transfers the complete circuits to their respective operating positions. Plate voltage appears at the modulator and

oscillator only when in the "send" position. By feeding the voltage to the center tap of the output choke, T5, we can use a smaller unit, inasmuch as the current in either half of the winding does not exceed 50 ma. and the use of a full winding choke, for example, is not required. This would require a rating of 100 ma., and it would be considerably more bulky. Other compon-

Fig. 1. Circuit Diagram.

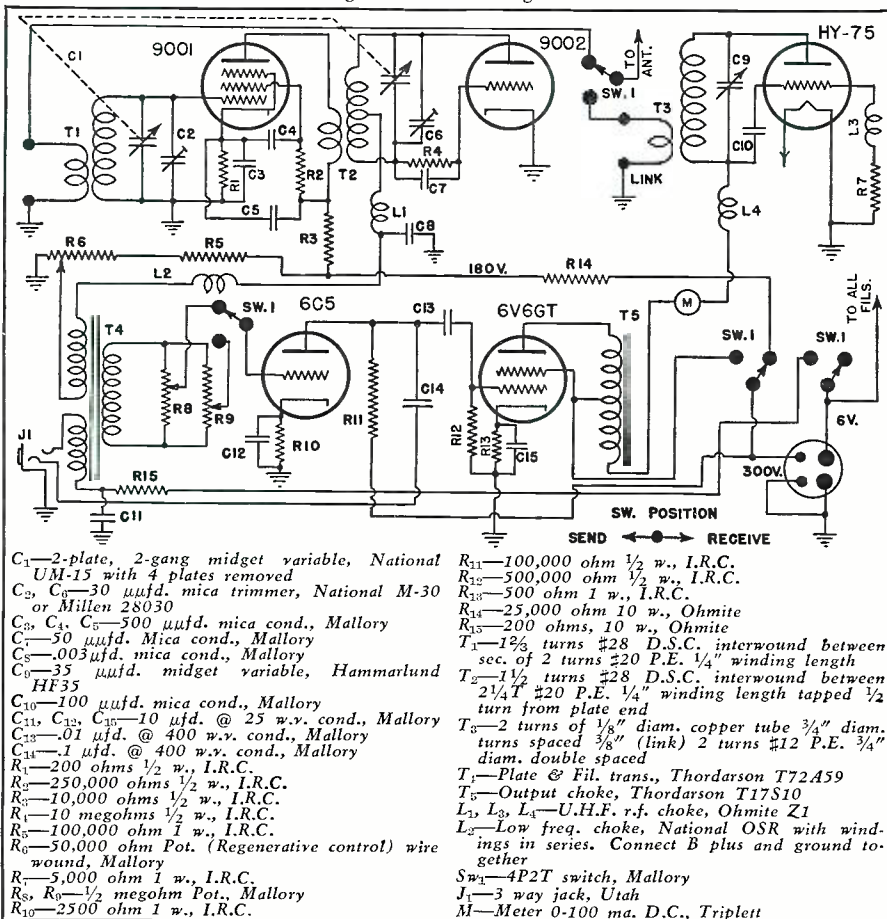

ents and specifications for the unit are given in parts lists.

### Receiver

Not many months before the suspension of amateur activity, there appeared on the market several ultra compact tubes of the "bantam" series which are designed for UHF applications. We are sure that many amateurs purchased these and have been seeking an opportunity to put them to use. They are suited ideally to ultra-compact layouts; in fact, the entire r.f. portion of the receiver section as used in this emergency portable occupies a space of only 4x4x1 3/4". This includes all receiver components, brackets and tubes. By building the receiver unit separately and by mounting associated parts on this set assembly, it is possible to wire completely this portion and to later mount it underneath the transmitter chassis, and then connect the necessary filament and plate supply leads.

This sub-assembly completes the r.f. section of the receiver, while the audio section is already provided at the transmitter. The padding condensers,

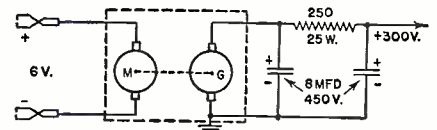

Fig. 2. Dynamotor filter circuit.

C<sub>2</sub> and C<sub>6</sub>, should be mounted as close as is possible to the two coils, T<sub>1</sub> and T<sub>2</sub>, as it is imperative to use short leads for these critical tuned circuits. Small brackets are formed, and are mounted directly on to the Isolantite of the two tuning condensers which are ganged by a flexible coupling. (Note that the rotor shafts do not return to a common point.) Therefore, the insulated type coupling must be employed. The two coils are wound on 1/2" Polystyrene rods, and the windings are held in place with coil dope.

Holes are drilled at either end of the rods, just large enough for a length of bus-bar to pass, and these serve as mountings for the completed coils. The bus-bar is then soldered directly to the two lugs of the two padders. The primary coil of T<sub>1</sub> is adjusted for best signal response over the entire tunable range. Once determined, it is held securely with coil dope. The adjustment of the primary on T<sub>2</sub> is not critical. However, it is well to experiment with this coil for best operation as determined by listening to a distant signal.

### Power Supply

A compact Carter dynamotor was on hand, and this was used to power the unit described. It fits nicely into the bottom of the 6x6x9" metal cabinet. Rubber grommets should be used to prevent transfer of vibration from the motor to the radio equipment. The two filter condensers shown on the small diagram are mounted on edge and placed in the position shown on the illustration. Also included is the

(Continued on page 66)

# Fundamental Atomic Physics

by **C. D. PRATER**

Bartol Research Foundation

***A discussion of fundamental theory which is essential to a complete understanding of the part that the atoms play in electronic tubes.***

NE of the most active fields of study today is electronics. The word electronics is so new that it has not found its way into the dictionary, but the American Standard Society defined it as "that branch of science and technology related to the conduction of electricity through gases or in vacuo." When electronics is mentioned the average radio technician or engineer thinks only of high vacuum tubes and ordinary gas-filled tubes such as the mercury rectifier. The study of these tubes is only a small part, though a very important part, of electronics. Some of the more important instruments with which electronics is concerned are given below:

- High vacuum tubes
- Magnitrons
- Thyratrons
- Strobo-trons
- Ignitrons
- Cyclotrons
- Betatrons
- Klystrons
- X-ray tubes
- Neon glow lamps
- Gas-filled rectifiers
- Voltage and current regulator tubes
- Photo electric cells
- Cathode ray tubes
- Electron microscopes
- Geiger Muller tubes.

When radio was first becoming important as a means of communication, the "useless" laboratory works of the

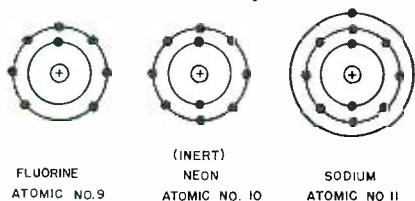

Fig. 1. Simplified picture of 3 atoms.

atomic physicists had little interest for the radio engineer, but today the works of the atomic physicists hold great interest for the radio engineer. This is because the radio engineer makes use of various electronic devices which depend upon some part of an atom for the transmission of electricity through gas or in a vacuum.

Since the time of the ancient Greeks there have been people who thought that matter was built of indivisible building blocks and not continuous as it appears to be. It was not until the last century that anything was done to prove this hypothesis. Since that time it has been found that matter is constructed of building blocks which are called atoms.

There are ninety two different types of these atoms, the elements. An atom is the smallest division that it is possible to make and have the element

recognizable as such, but the atoms themselves are built of still smaller blocks, the electrons and protons. Each element differs from other elements only in the number of these electrons and protons which go to build it. The electron is a negatively charged body having an electrical charge of  $1.6 \times 10^{-19}$  Coulombs and a mass of  $9 \times 10^{-28}$  grams.

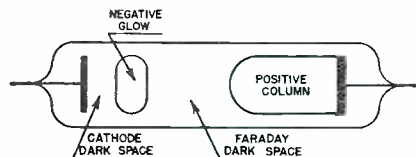

Fig. 2. Glow discharge at reduced pressure.

The proton has a positive charge exactly equal to the negative charge on the electron and a mass of  $1.6 \times 10^{-24}$  grams.\* The proton then is approximately 2,000 times as heavy as an electron. The simplest of all atoms is the hydrogen atom which consists of one electron and one proton. The simplest picture of the hydrogen atom is a miniature solar system with the heavy proton as the central "sun" and the electron as a planet revolving around the "sun." The hydrogen atom has relatively more empty space in it than the solar system, as can be seen if the central proton is imagined to be "blown up" until it is the size of the sun. Then the planetary electron would be approximately one hundred times further from the sun than the earth. It would be further out than the farthest planet, Pluto, which is forty times farther from the sun than the earth. The central "sun" of an atom is called the nucleus.

The nucleus always contains enough protons to give it a positive charge to exactly balance the total negative charge of the planetary electrons. Thus the atom itself is neutral. A list of the elements is given in Table I. The number of planetary electrons is given in the column marked atomic number. The nucleus determines the weight which is given in the column marked atomic weight. This is a relative weight based upon oxygen weighing 16 units. The number of actual protons in a nucleus can be greater than the number required to neutralize the charge of the planetary electrons because the nucleus itself can contain

electrons. This will account for the way in which the atomic weights rise from element to element.

A simplified picture of three atoms with consecutive atomic numbers is shown in Fig. 1. This figure shows how the electrons arrange themselves in orbits. The first orbit may contain two electrons, the second orbit may contain eight electrons, the third orbit may contain eight, and the fourth orbit may contain eighteen, etc. The chemical properties of the elements depend upon the number of electrons in the outer orbit. The electrons in complete orbits are more firmly held than those in the incomplete orbits. An atom with a deficiency of electrons in its outer orbit will try to become more stable by gaining electrons until its outer orbit is filled or losing electrons until this outer orbit is completely empty leaving the atom with only completely filled orbits.

This is what happens when atoms combine to form molecules. For instance, the sodium atom which has one electron in its outermost orbit and the fluorine atom which has seven electrons in its outer orbit will form a chemical compound by the sodium atom giving up its one electron to the fluorine atom. Atoms may combine even if they only partially fill one another's orbits. These molecules are not as stable as the molecules in which each atom has its orbits "satisfied."

An example of this is given by oxy-

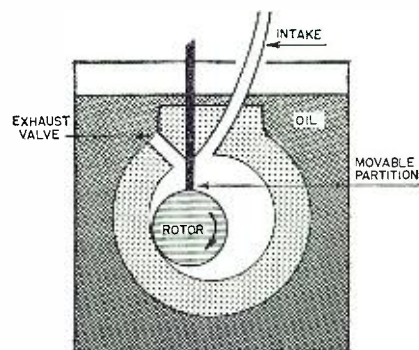

Fig. 3. Rotary mechanical pump structure.

gen which has an atomic number of eight. This means that the outer orbit has only six electrons so the oxygen atoms share their electrons with one another to form a molecule. It is obvious that it would be impossible for

each atom to completely satisfy the other. The Neon atom which has a full outer orbit will be inert. When an atom loses electrons to another atom, the atom becomes positively charged. When an atom gains electrons, it becomes negatively charged.

In metals one or more of the electrons in the outer orbit are so loosely held that they are free to move within the metal as if they were a gas in free space. It is these electrons that carry the electricity in metals. The amount of influence the atoms have over these electrons determines the ease with which the metal will conduct electricity. If the electrons are so tightly held to the atom that they can not get free, the substance is then an insulator. There is a class of substance which lies between conductors and insulators called semi-conductors. At ordinary temperatures these substances are insulators, but at higher temperatures they become conductors. The reason for this is that on heating, a certain number of electrons of the outer orbit can acquire enough energy to get free to move within the substance and therefore carry current.

These semi-conductors play a very important part in electronics as will be seen in subsequent articles. The

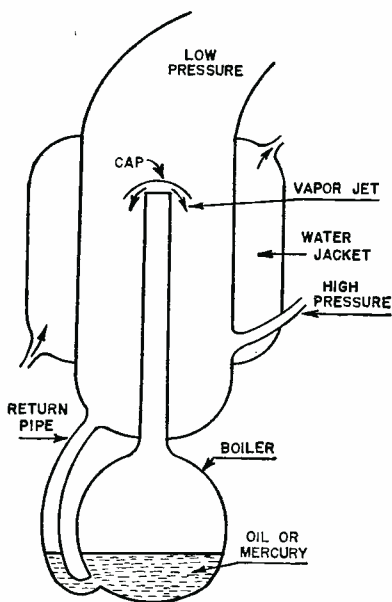

Fig. 4. A simple diffusion pump.

electrons in all these substances are confined within the surfaces because the atoms of the solids are fixed and can not move about, and as soon as the electron tries to move through the surface, it leaves the surface positively

charged, thereby setting up forces pulling it back into the solid. If the electrons can get enough energy to overcome this force, they may get free of the metal and out into space. These free electrons from solids supply the high vacuum tubes with current carrying agents. They also serve to initiate and maintain the flow of current in gas-filled tubes. Since they are going to be so important to us in the study of electronic devices later on, it will be well to examine this freeing of electrons from solids more closely. The amount of work that an electron must do to get through the surface is not the same for all substances.

The electrons at ordinary temperatures do not have enough energy to overcome this force, but on heating to a sufficiently high temperature, a sufficient number of the electrons to be measurable will be able to escape from the surface. The temperature at which this occurs depends upon the amount of work that an electron will have to do to get through the surface and as was said above this is different for different substances. Therefore, the temperature at which the number of free electrons become measurable is different for different substances.

This method of getting electrons from solids is used in the hot cathodes. Electrons within the surface of a substance may acquire sufficient energy to escape through the surface by being irradiated with radiations such as light and X-rays. This method is used in the photo electric cell. The electrons within the metals may also acquire sufficient energy from atomic particles which strike the substance with sufficient velocity from the outside. They might be considered as simply knocking the electrons out of the substance. This method of obtaining free electrons is used in multiplier tubes. It also plays a very important part in gas-filled tubes.

Gases have a marvelous property of changing from a good insulator to a good conductor in a few millionths of a second. If it was not for this property, it would be impossible to interrupt circuits without providing some sort of elaborate device which would do the same thing that gases do so simply.

Gases consist of myriads of atoms or molecules moving in a rapid irregular manner. The number of molecules in a cubic centimeter is so large that it is beyond comprehension. There are twenty seven million million million, ( $2.7 \times 10^{19}$ ), of them in every cubic centimeter of gas. This causes gases to appear to our senses as a continuous fluid. Although the atoms or molecules are in rapid motion, it does not impress itself upon our senses.

The molecules will have a mean speed, a mean energy and a mean distance which they can go before they collide with another molecule. These means are characteristic of the state in which the gas is in. The mean speed, mean energy and mean free

(Continued on page 62)

TABLE I  
THE ELEMENTS

Atomic Number	Name	Approximate Atomic Weight	Atomic Number	Name	Approximate Atomic Weight
1	Hydrogen	1	41	Columbium	93
2	Helium	4	42	Molybdenum	96
3	Lithium	7	43	Masurium	—
4	Beryllium	9	44	Ruthenium	102
5	Boron	11	45	Rhodium	103
6	Carbon	12	46	Palladium	107
7	Nitrogen	14	47	Silver	108
8	Oxygen	16	48	Cadmium	112
9	Fluorine	19	49	Indium	115
10	Neon	20	50	Tin	119
11	Sodium	23	51	Antimony	122
12	Magnesium	24	52	Tellurium	127
13	Aluminum	27	53	Iodine	127
14	Silicon	28	54	Xenon	130
15	Phosphorus	31	55	Caesium	133
16	Sulphur	32	56	Barium	137
17	Chlorine	35			
18	Argon	40			
19	Potassium	39			
20	Calcium	40	72	Hafnium	179
21	Scandium	45	73	Tantalum	181
22	Titanium	48	74	Tungsten	184
23	Vanadium	51	75	Rhenium	189
24	Chromium	52	76	Osmium	191
25	Manganese	55	77	Iridium	193
26	Iron	56	78	Platinum	195
27	Cobalt	59	79	Gold	197
28	Nickel	59	80	Mercury	200
29	Copper	64	81	Thallium	204
30	Zinc	65	82	Lead	207
31	Gallium	70	83	Bismuth	209
32	Germanium	73	84	Polonium	210
33	Arsenic	75	85		
34	Selenium	79	86	Radon	222
35	Bromine	80	87		
36	Krypton	83	88	Radium	226
37	Rubidium	85	89	Actinium	—
38	Strontium	88	90	Thorium	232
39	Yttrium	89	91	Protoactinium	—
40	Zirconium	91	92	Uranium	238

57—71  
Rare Earths

# AVIATION RADIO COURSE

by PAUL W. KARROL

**Part 8 discusses the proper care and use of the most commonly used radio tools for aircraft radio installation and maintenance.**

TALKING through any one of our aviation radio factories on an inspection tour one will see workers who waste no time by "superfluous motion." Each motion is work, tools are always handy; no time is lost looking for tools or material. When the tools are used, they "work." They are constantly sharpened, aligned, and oiled; proper care is taken at all times.

Small parts which show signs of wear are replaced as soon as it is seen that they will impair the efficiency of the tool. Tool inspections are frequent, too, and each workman makes certain that one one else uses his tools by marking them and by constant vigilance over his tool chest.

The aviation radio technician should bear in mind that his tools will serve him best if he learns how to use them correctly and how to take care of them.

Without soldering irons (commonly called soldering coppers), modern aircraft and ground station radio equipment could not be properly maintained. It is common practice to have on hand more than one soldering iron, usually three. These are: the heavy, medium, and light irons.

The heavy iron containing a 1½ or 1¼ inch bit is used for the jobs requiring an unusual amount of heat, viz., large diameter shielding, wide bonding strips, etc. The medium iron is used when working with bus bar wire, circuit wire (No. 12 or smaller), and for general work around transmitters, receivers, etc. This iron is the most commonly used. The light iron is used to solder small connections, wire smaller than No. 20 and is used where an excessive amount of heat would damage a part, such as a wax filled condenser (small), meters, tinsel wire, etc.

The medium iron has a bit ¾ inch or larger in diameter, and the small iron has a bit varying from ½ inch to ¼ inch.

"Pencil soldering irons" are often used for intricate work in highly sensitive indicating instruments which use very small wire and very small components.

Blow torches are often used where a large amount of heat is required and where an open flame would not be objectionable. Their use around aircraft is discouraged. In some instances, they may be used to heat large soldering coppers.

Soldering irons are either electrically or flame heated; the former being used the most.

Soldering is an operation which ap-

pears simple to the uninitiated. However, there is more to it than just applying heat and solder to two metals. Good soldering is the result of practice, and is pre-requisite to good electrical connections. The average radio receiver contains about ¼ pound of solder distributed throughout the chassis.

Inferior soldered connections are characterized by appearance and stability. When a connection is made with an iron which hasn't reached the correct temperature, "cold" soldered joints are bound to result. (A cold soldered joint is one which is covered by solder which does not make good connection.)

Before soldering should be attempted, the bit of the iron should be cleaned and tinned. This operation is known as tinning. The copper bit is removed from the iron, placed in a vise and an "old" file (one which is worn) is used to dress the tip. All oxidation is removed by filing, the bit is replaced in the iron and heated. As soon as the tip begins to turn color (a dark orange) resin core solder is applied to the tip so that it is covered with a thin film of solder. The soldering iron is now ready for use.

When soldering wires together, connection is made mechanically first, then heat is applied underneath the connection and solder is applied to the top. Excess solder on the bit can be removed by wiping with a rag or flip-

ping the iron. Before soldering phone plug tips, spade terminals, etc., to tinsel wire it is necessary first to seize the copper conductors with seizing wire, (No. 22 or smaller). The soldering iron must be very hot and the iron is not held to the connection for any great length of time; the connection is merely touched so that the solder is melted. Terminals of UHF tubes (tail terminals) should be carefully soldered to circuit terminals; the iron is only applied long enough to affect connection. When unsoldering a connection, a small amount of solder applied first with the iron will loosen the joint and speed up the operation.

The correct choice of the iron to do a certain job must not be taken too lightly. One would surely not use a heavy iron to solder connections to a small terminal; nor would one use a pencil iron for soldering bonding strips. The amount of heat necessary to affect connection, the size of the connection, and the type of metal, determines which iron to use. Experience will do the instructing here.

Too much solder is worse than none at all. Bulky connections take up valuable space and at the same time are not conducive to good soldering practice.

Acid core solder is never used for making connections in a radio set; its corrosive action is detrimental to good electrical connection and at the same time is unsightly. Resin core is the only solder which should be used by the aviation radio technician, unless he has large pieces of tin, galvanized iron, etc., to solder; these won't be found in the average piece of equipment he will work on.

Because the heating element in the electrical soldering iron is fragile, the iron should be handled with care. It should never be used to pound a connection into place, nor should it be used as a "prying tool."

A three cornered file is used where fine close cutting is necessary, and the half round bastard file is used where both flat and round work are found.

Files are classified as follows: coarse cut (very coarse); bastard cut (coarse); second cut (half smooth); smooth cut (smooth); and dead smooth (very smooth).

All files regardless of the type should be cleaned frequently with a wire brush and should not be used for prying, or as punches. Too, they should be stored where there is no danger of rust. A small amount of oil rubbed over the file will tend to

(Continued on page 81)



"Hurray! I made a K6 contact."

# PRACTICAL RADIO COURSE

by ALFRED A. GHIRARDI

*Part 9 of the present series discusses various unmodulated and modulated R.F. carrier waves and how they are used.*

## The Signal-Selecting System

In the previous lesson of this series the use of a "resonant" or "tuned" electrical circuit (comprising an inductance and a condenser combination) to make possible the selection of the received signal of a desired radio transmitter from the signal of all other transmitters affecting the receiving antenna at the same time was ex-

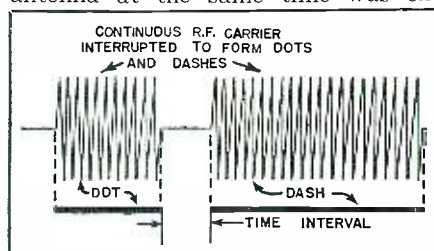

Fig. 1. Typical wave-form of dot-dash.

plained and illustrated. Tuned electrical circuits form the very heart of the signal-selecting system of every receiver.

## Amplitude, and Frequency Modulation Systems

Radio waves are radiated into space, at the speed of light, from the antenna system of the transmitter. These waves have two important characteristics, frequency and intensity or amplitude. All present radio communication systems function by varying either the frequency or the amplitude of the radiated waves in accordance with the message to be sent, whether this message is in the nature of timed interruptions of long and short duration (forming a code system), or variations in accordance with the amplitude and frequency of the audio frequency air pulses comprising speech and music to be transmitted. The system which depends mainly upon varying the frequency of the radiated waves in order to transmit the information is commonly known as the frequency modu-

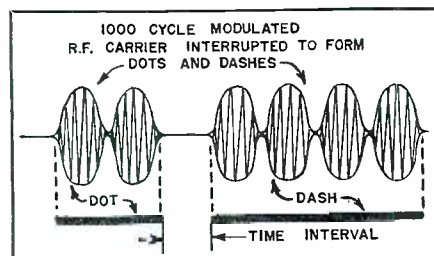

Fig. 2. Modulated continuous wave.

lation (F.M.) system of radio communication. Frequency modulation will be studied in greater detail in a later lesson. The system which de-

pends upon varying the intensity or amplitude of the radiated waves is known as the amplitude modulation system. The radio-frequency wave generated for transmission by the transmitter is called the carrier.

## Continuous-wave (CW) Code Transmission

In the amplitude modulation system of radio transmission there are two methods by which code messages may be transmitted. The high-frequency carrier wave (whose frequency is that assigned to the Transmitter) may simply be started and stopped by a transmitting key to form signals of short duration (*dots*) and of longer duration (*dashes*) in accordance with a pre-arranged code system of dots and dashes to form letters of the alphabet. Fig. 1 shows graphically what this "keying" does to the wave. The transmitting key is depressed for a fraction of a second for a "dot" signal, then left open for a fraction of a second and then depressed for a period about three times as long as the first for a "dash" signal.

The two radio-frequency groups of



Fig. 3. Conventional telegraph key.

waves of different duration are received and interpreted by the receiving system as a dot and a dash. Rapid transmission of such series of "dot" and "dash" signals constitute the message in code. Since the carrier frequency employed in this system is a radio frequency and is much above the audible range, in order to make the signals audible in the receiver the receiving system must contain a radio frequency oscillator whose frequency is adjusted so its signal beats with the incoming signal to produce an audible tone (usually 1,000 cycles since this lies in the most sensitive hearing range of the human ear). The operator then hears a 1,000 cycle tone that is interrupted in accordance with the dots and dashes of the code employed.

## Interrupted Continuous-wave (ICW) Code Transmission

In the keyed interrupted continuous-

wave (ICW) system the radio-frequency carrier which is continuously modulated at some fixed audio frequency rate by one of several methods is "keyed" to form the dot and dash signals for code transmission. The illustration of Fig. 2 shows the modu-

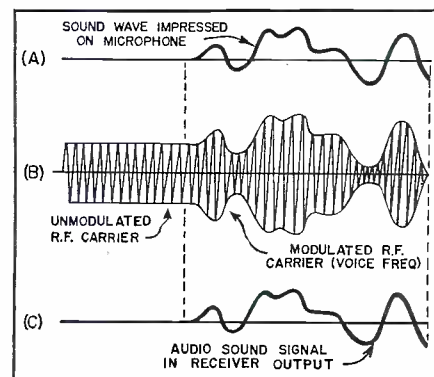

Fig. 4. Unmodulated and modulated carrier.

lated continuous radio frequency carrier "keyed" to transmit a dot and a dash. Since the received signal is already modulated, the desired audio frequency to actuate the earphones or loudspeaker is produced in the receiver without need for the local oscillator that is necessary in the continuous wave (CW) system described previously. A commercial transmitting "key" for code transmission in the systems of Figs. 1 and 2 is illustrated in Fig. 3.

## Amplitude-Modulated Radiotelephony

In the amplitude-modulated system of radiotelephony so widely used in broadcasting, the amplitude of the radio frequency carrier (shown towards the left in Fig. 4B) is varied or "modulated" in exact accordance with the audio frequencies (A) originating at the microphone of the transmitter. In this system, the original carrier is of constant amplitude, being modulated, as shown at the right (Fig. 4B), only when the audio-frequency control is impressed. The audio (sound) signal resulting in the receiver output is shown at (C). Notice that it is identical in waveform to that of the original sound impressed upon the microphone at the transmitter. This is often referred to as the modulated continuous-wave system.

## System of Radio Reception

Modern radio receiving apparatus differs greatly in design and complexity depending upon the use to which it is put, the type of radio signals it is designed to receive, its cost, the form of power supply available for operat-



ing it, etc. Thus we have miniature pocket receivers and small portables operated from self-contained batteries, midget receivers and larger console receivers for the home, powered from a.c. or d.c. electric light lines, compact rugged receivers for emergency and aircraft receivers, auto radios, "walkie-talkies," professional receivers of high

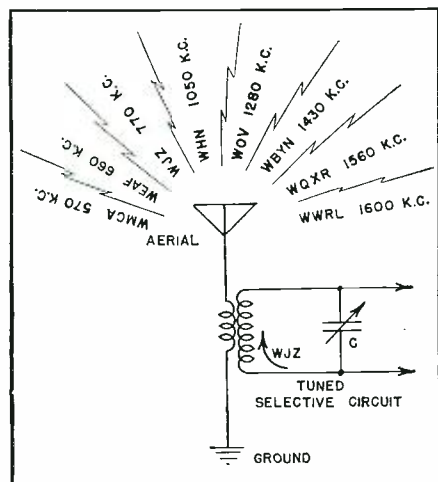

Fig. 5. Individual station selection.

precision, etc. However, the fundamental principles underlying these various designs are all fairly similar and not really complicated if they are studied systematically.

Fundamentally, a radio receiver complete with its built-in or external antenna system is a device for absorbing a small amount of power from the passing radiation field of the distant transmitting station whose signal it is desired to receive, selecting this from the signals of all other stations received at the same time, and amplifying it sufficiently to operate a translating device such as a pair of earphones, loudspeaker, television, etc.

Because it is practically immersed in the radiation field of the passing radio wave the antenna will have minute alternating e.m.f.'s induced in it, of the same radio frequency as that of the radiation field and the transmitter. Furthermore, the amplitudes of these e.m.f.'s will vary directly with the instant-to-instant strength of the field, and hence with the modulation of the carrier wave.

Consequently, the modulated carrier being transmitted will be reproduced exactly in the antenna system of the receiver, only in weaker form. There will usually be, however, several other stations transmitting at the same time on very nearly the same frequency, and received at nearly the same or greater, strength. As explained in the last lesson, a tuned, or selector circuit that may be adjusted to be in resonance at the frequency of the signal it is desired to receive is necessary to discriminate against the undesired signals and to select the desired signals. In practice, several such tuned circuits are required to provide adequate selectivity. One such circuit seldom suffices. However for the sake of simplicity at this point in our stud-

ies we will assume that tuned circuit consisting of a suitable inductance coil and condenser will provide the proper selectivity. Such an arrangement is illustrated in Fig. 5, where the tuned circuit L-C is adjusted so that only the signal of station WJZ (770 kilocycles) is allowed to come through. This will appear in the form of an oscillatory current in the tuned circuit, as indicated.

With the signal current of the proper station tuned in and flowing in the receiver circuit it next becomes necessary to dissociate the message from its radio frequency carrier. This important operation is performed by what is known under the various names of *detector*, *demodulator*, etc.

#### Demodulating the Received Carrier

The actual process of demodulating the radio-frequency carrier is rather simple. First, the radio-frequency a.c. voltages appearing across the tuning circuit where they are *rectified*. That is, the entire negative characteristic of the radio-frequency signal current is eliminated or suppressed. The part that remains consists of a series of rapid positive alternations, the *average*

value of the rectified signal current at each instant. This is usually accomplished by feeding the rectified signal current to the electromagnetic winding of earphones or a loudspeaker (if there is sufficient energy available to operate it) which does nothing more than set the surrounding air in motion by means of a diaphragm or other surface that vibrates back and forth exactly in conformity with the moment-to-moment variations with the audio signal current fed to it. Thus, sound waves are produced by the signal.

#### How the Detector Circuit Operates

A simple circuit for the reception of ICW code signals or of modulated CW signals is illustrated in Fig. 6. We will consider first what happens in this circuit during the reception of modulated CW signals. The radio-frequency e.m.f. induced in the antenna by the modulated radiation field has the same moment-to-moment audio modulations as those impressed on the carrier at the broadcasting station. This e.m.f. causes a corresponding circuit to flow through the primary winding  $L$  of the transformer. The rapidly varying magnetic field set up by this primary current induces corresponding larger

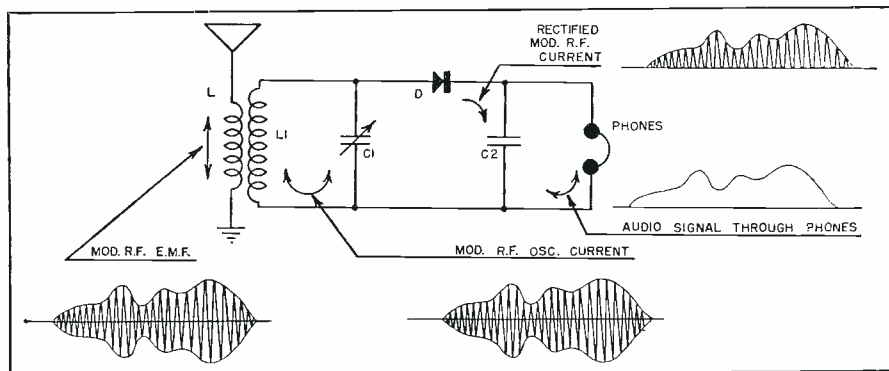

Fig. 6. How a modulated signal passes through circuits of a crystal det.

value of which will conform closely to the envelope of the modulated wave and will therefore contain the desired intelligence. *Detection or demodulation* is, therefore, the process of reproducing the transmitted information from the modulated radio-frequency wave.

The final step in the receiver is to translate into sound energy the electrical energy represented by the *aver-*

voltages in the secondary winding  $L_2$ . These cause an oscillatory current to flow in the tuned resonant circuit  $L_1C_1$  as a result of which continually varying r.f. voltages appear across the detector circuit. The crystal detector  $D$  acts as a rectifier and allows these voltages to send a rapid succession of radio frequency current pulses of varying strengths through it in *one di-*  
(Continued on page 64)

Fig. 7. Reception of an ICW code signal in a simple crystal det. circuit.

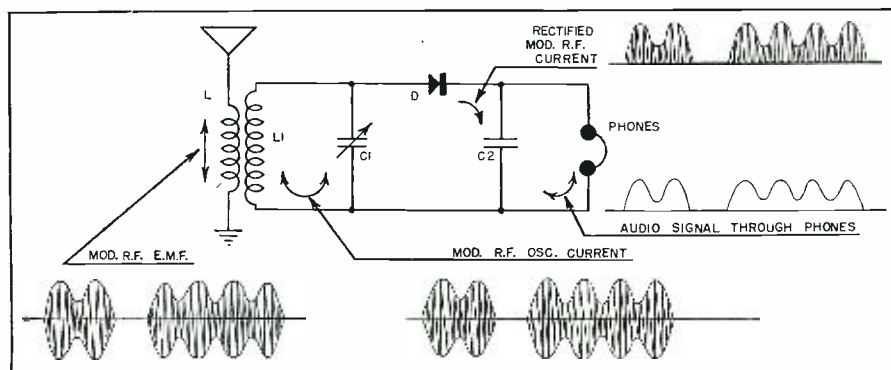

# TRAINING RADIO OI S



Development work in progress in one of the classrooms. Note the large vacuum tubes mounted securely onto boards.

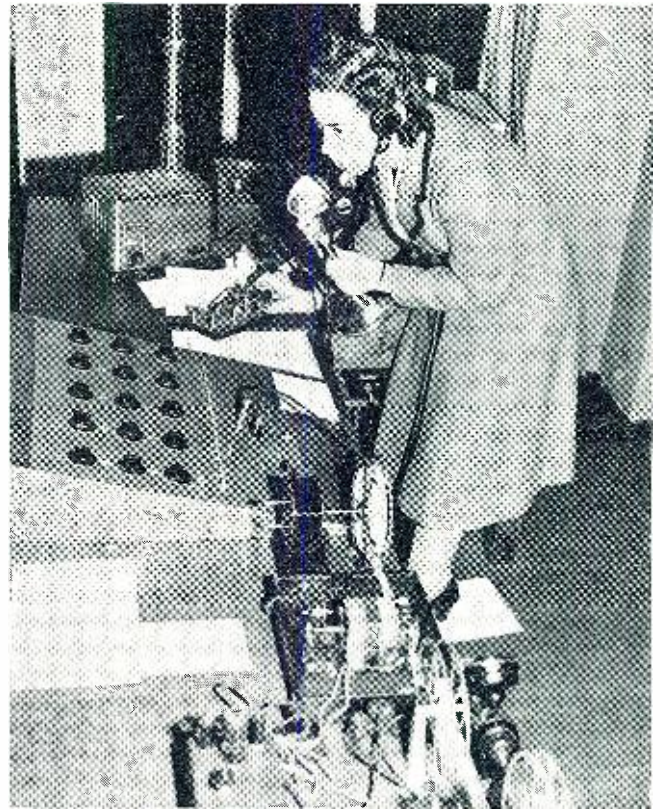

Dorothy Kaufman shown at the master code transmitter platform. Tape-senders may be seen in foreground.

by **LEWIS WINNER**

***The shortage of radio manpower has called for expanding activity to train men and women to fill land and air posts.***

**W**ITH the increased use of airplanes for so many projects vital to the successful conduct of the war, have come many attendant problems, the most important of which is manpower, particularly manpower in radio. This need is not only one affecting the military but also the civilian circles as well. The military are absorbing the qualified civilian communications personnel so rapidly, that they are straining the sources of available talent. And not only is the civilian problem that of replacement, but of additions too, for today, we have not only increased military and essential civilian transportation to cope with, but also cargo transportation.

In cargo transportation lies probably one of the greatest problems of radio manpower. There is this increasing need for flight operators, because cargo planes carry flight radio officers, whereas the passenger planes use the pilots for communications purpose. In addition the transport planes em-

ployed all 'phone radio operators, whereas the cargo planes will need operators who can transmit in code, as well as phone. Of course, it must be remembered that radio operators were always used on oceanic service, but this form of travel has increased too.

In the past radio operators were recruited from the sea-going class of operators and advanced amateurs and some students. These men were trained for airline procedure after they were hired. All that was required of them as airline prerequisites was code proficiency and the necessary license from the Government to operate a station. Although it was true that the operators had to transmit at exceedingly high speeds, most of the operators were expert at that, and thus the training wasn't too extensive. It was actually just a case of becoming acquainted with airline procedure. To train these men and others in the mechanics of radio, a special schooling

course, extending over a period of up to four years, was given. Upon completion of the apprenticeship training period and provided the apprentice had obtained a second-class telephone operator's license, he became a mechanic. Sessions were held several nights a week for theory and practical work was given a few hours during the day, under supervisory mechanics.

Today though, time is at a premium. It is impossible to spend a year or so on an educational project, and in addition there is the scarcity of marine operators and amateurs. Thus the airlines have had to decide on an accelerated program, a program that would shrink the training period to a matter of months. This they decided to do by supplementing their training program with that of independent schooling. The problem was a tough one for there were few who not only could teach the assortment of airline subjects necessary, but there were few who were even available to

# FOR THE AIRLINES.



Men must study the theory and operation of motors and generators. Aircraft radio communications depend on such units for power source.



Instructor shows students how to operate the oscilloscope. Note breadboard circuits.

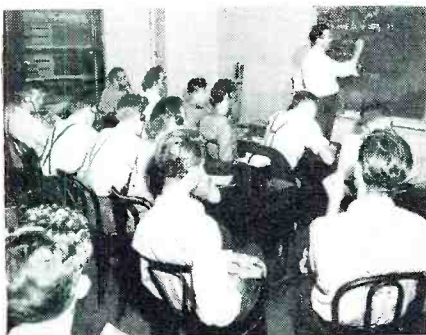

The study of airline traffic technique is an essential part of the extensive training.

This is a representative collection of material that students must study.

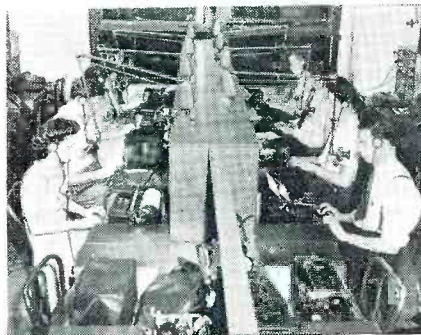

Microphones provide "actual-service" training in the traffic room.

Many meters are required for the analysis of many radio circuits.

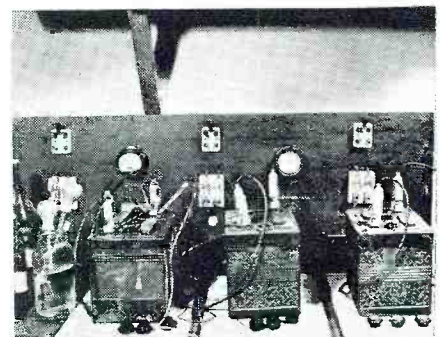

Characteristics of storage batteries are studied at this bench position.

Students study problems of maintenance in well-equipped laboratory.





Frank Melville, founder of the school, interviews a new prospective student.

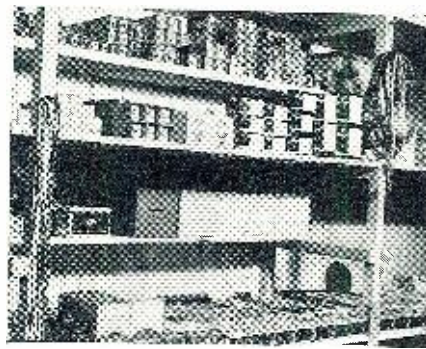

Part of the well-supplied materiel closet. Trays hold smaller parts.



Circuits are analyzed with plenty of up-to-date laboratory equipment.

do this. Fortunately though some air-minded youths realized this problem too. They wanted to get a rapid course of training, and thus they went to a friend of theirs, a friend who proved a friend indeed. He was the ace transatlantic flight officer Frank Melville. He was asked by these boys to outline a course on aircraft radio. He agreed to do this and coach them, too.

They came daily to his home in Long Island. Within a few months other boys joined the group and soon the class was too large for the Melville living room. It was transferred to the sun porch, and then to some rooms in an office building in Flushing, New York. It wasn't long after that the school had to move to a building in New York City, with several floors and nearly a thousand students occupying them. For among others, the airlines had heard of this project and immediately began using this training course as the one supplementing theirs.

The boys that took the first courses in the Melville living room, the Beaumont brothers, are now employed by the *American Airlines*. And there are countless others that are also filling the posts, perhaps not as rapidly as the demand requires, but certainly at quite an increased tempo as compared with the older processes. Every attempt is being made to expand this training program to provide all of the necessary communications personnel.

Not only is the school training men, but women too, and from all walks of life. No longer do we have most of the students from the radio-experience classification. Instead we have students who were furriers, painters, musicians, arc welders, florists, etc.

In airline practice, all of the procedures are quite different from those encountered in usual communications work. As mentioned previously, speed, extremely high speed, is one of the essentials. The need for this high speed transmission and reception is prompted by the speed at which modern planes operate today. To transmit message effectively, they must be sped to their destination so that any corresponding replies may be radioed to reach the speeding plane, before, let us say, the plane lands or is out of reach. The operator of the key must be extremely alert, for unlike the marine operator his ship is racing along with no time allotted for stopping and studying of conditions. His decisions must be instantaneous and accurate. This is particularly so during weather emergencies.

Such speed is attained at the school by many usual methods, one of which involves the use of a master code board. By way of this board, students are individually studied and listened to. Thus it is not necessary for the instructor to step down among the students and upset their copying speeds. While listening in, the instructor can detect any one of a variety of defects in transmission. Students are taught to copy by hand and by typewriter, and from hand-operated and automatic tape recorded machines. Both the hand-copy method and typewriter method are taught, because there are many instances where typewriter space isn't available and copying by hand is essential and vice versa.

The attainment of speed is not just a matter of pounding out a series of characters. It involves complete

knowledge of the many forms of messages that airline operators must send. For instance, an operator must be familiar with reservation messages, meteorological messages, operations messages, flight reports, dispatches and flight plans. The reservation message requires a knowledge of all inter-company forms and blanks of which there are quite a variety. The weather forecast message demands a knowledge of meteorological symbols, as well as a knowledge of data on the ceiling, sky, visibility, barometric pressure (in millibars), temperature, dew point (in degrees Fahrenheit), wind altimeter setting, etc. In addition a variety of special symbols used to indicate wind conditions, sky and ceiling characteristics, must be known with thoroughness.

Now in order to transmit these messages effectively the prospective operator must become familiar with the various types of services in which these messages are used. There is, for instance, a service known as the aviation service. This is a radio communication or special service carried on by aircraft stations, airport control stations, aeronautical and aeronautical-fixed stations, instrument landing stations and flying school stations. Then there is the public aviation service, in which the communication facilities are open to public correspondence to provide public communications to and from aircraft in flight. Incidentally the aircraft station mentioned is identified as a radio station on board any aircraft, either heavier than air or lighter than air, and other than a public aircraft station.

An aeronautical station is one which  
(Continued on page 59)

An interior view of the special code board that includes eighteen positions.

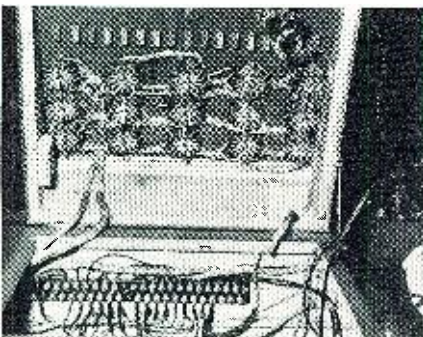

One of the glass-enclosed classrooms. These are almost completely sound-proof.

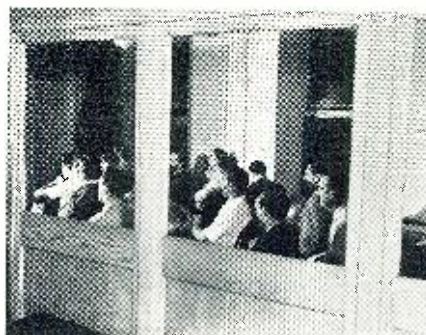

Repairing one of the Boehme automatic transmitters. Used widely by airlines.



# Manufacturer's Literature

Our readers are asked to write directly to the manufacturer for this literature. By mentioning RADIO NEWS and the issue and page, we are sure the reader will get fine service. Enclose the proper sum requested when it is indicated. This will prevent delay.

## Motor Fitness Manual

Motor fitness requirements is the subject of a new 40-page illustrated bulletin (GED-1017) recently issued by the *General Electric Company*. Although primarily intended for plants converted to war production, the bulletin will prove valuable in all plants in which motors are widely used.

The bulletin discusses the following subjects in a highly comprehensive and informative manner: How to get the most service out of old and new motors, "switching" motors from one job to another, and equipping old machines with new motors.

Also, selection and application of motors, various types of motor enclosures, secondary ratings of standard integral-hp. motors, ways to determine  $WR^2$ , motor maintenance, full load currents of motors, selection of a.c. control, and the use of the hook-on voltammeter. A supplement explains how to save critical motor materials, including WPB recommendations, and information on the use of load-time-temperature charts.

The bulletin is arranged throughout for quick reference.

## G.E. Announces Technical Booklet

A new technical booklet on Designing Molded Plastics Parts has been issued by the *General Electric Plastics Department*, One Plastics Avenue, Pittsfield, Mass.

The booklet is an assembly of an informative series of ads carried in trade papers over a period of several months, each ad dealing with some technical phase of designing molded plastics parts.

Subjects covered are inserts, shrinkage, tolerances, wall thickness, holes and undercuts, ribs, bosses and fillets. The material is intended for product engineers and designers.

## Tube Life

This pocket size booklet "Thirteen Ways to Prolong Tube Life" gives several helpful hints on getting the longest service from electronic tubes. It considers plate dissipation, proper tuning of circuits, reduction of "no-signal" plate current in Class B audio amplifiers, minimizing stray circuit losses in Class C stages, adjusting grid drive, maintaining rated filament voltages, preventing parasitic oscillations and

(Continued on page 53)

# 23 YEARS AGO in RADIO

[ CONDENSED FROM RADIO NEWS, 1917 ISSUES ]

## Tree Antenna

IN 1904 the author conducted some experiments with a view to utilizing growing trees as antenna for radio telegraphy and discovering the efficacy in a general way, of using a direct metallic contact to certain trees (principally eucalyptus) to increase the audibility of radio signals.

It was found that the regular Army buzzer telephone and telegraph were inoperative with any ordinary ground or earth, but became operative when connected to a metallic nail driven in the trunk or roots of a tree. This incident led the author to pursue the subject experimentally in the autumn of 1904.

In connection with the organization and development of Transatlantic radio reception, which was carried out during the period of the war to provide against the possibility of the interruption of the submarine cable system, the Signal Corps established a chain of special receiving stations in different parts of the United States to copy and record enemy and allied radio messages from European stations for the information of our Army General Staff.

It was immediately discovered that with the sensitive amplifiers now in use it was possible to receive signals from the principal European stations by simply laying a small wire netting on the ground beneath the tree and connecting an insulated wire to a nail driven in the tree well within the outline of the tree top.

One of the best receiving arrangements was found to be an elevated tree earth-terminal in the upper part of the tree top as described later, and an earth consisting practically of several short pieces of insulated wire sealed at the outer ends radiating out from a common centre, and buried a few inches beneath the surface of the ground in the neighborhood of the tree.

## The R-34 Radio Equipment

THE success of the British Dirigible R-34 in landing at Mineola, L. I., July 7th, after a voyage of 108 hours from East Fortune, Scotland, a distance of 3,200 miles, not only established a new mark in lighter-than-air craft flights, but from the distances covered by its radio equipment a great stride has been made also in aircraft communication.

Since the safe piloting of the machine depended on wireless communication for weather reports, time, etc., a very elaborate system of transmitters and receivers was installed and a pioneer in aircraft radio was selected as Officer in Charge.

The R-34 is equipped with four transmitting sets: a high power sustained wave set for long distance work, a medium power sustained wave set for distances up to 500 miles, a damped spark transmitter for damped receptor stations, and a wireless telephone set which is the medium power set so arranged as to permit radio-telegraphic or telephone communication to be carried on. The antenna consists of a phosphor bronze stranded cable 500 feet in length which is lowered from the forward gondola, in the middle of which the radio room is situated. This cable is provided with a weight on its farthest end from the gondola and tends to maintain the wire at right angles to the line of the big ship.

## The Auto Radiophone

THE present stage of radio telephone development has placed this form of communication on such a highly practicable plane that its rapid adoption for many useful purposes is only a matter of a very little time.

Having experimented considerably with vacuum tube radio telephones during the past few years, and being impressed by the adaptability of this type of radio communication to small antennae, the writer desired to make some tests with a radio telephone equipment installed in a motor car.

At first it was decided to use a flat loop as the radiating member, but this was abandoned in favor of a four-wire flat top antenna, used in conjunction with the frame and body of the car as a counterpiece. It was found best to depend on efficient radiation of the transmitted energy and sufficiently amplified incoming signals, than to sacrifice radiated energy in favor of the advantages of the loop for receiving.

The antenna system was constructed along portable lines, the supporting masts being fitted with socket joints for assembly and attachment to the car frame. When not in use the entire antenna system was slung under the running board on hooks provided for this purpose. The antenna wire was the same as used on aircraft and the non-kinking characteristics of braided wire made it more suitable than other kinds.

## Developments in Wireless Telephony

APPARATUS for this purpose had been considered from almost the start of wireless communication of any kind. It was assured if we could provide the facilities for one human being to talk to another and eliminate intermediary operators, that the utility of the telephone could be increased tremendously.

In the early days it seemed almost impossible to do anything with radio telephony because the spark system only was known, by which system with a sudden impulse you produce a train of waves with big spaces between them. This did not lend itself to speech because the continuous nature of telephone communication entailed continuous wave train type of transmission. In 1913 and 1914, the American Telephone and Telegraph Company, in connection with the development of their transcontinental line, found an amplifying apparatus now commonly called the vacuum tube. It seemed that it not only possessed the requisite properties for generating the continuous wave of radio frequency and of putting the voice frequency on this, but also could amplify it up to sufficient horsepower for long distance transmission. The result was that in the latter part of 1914, his company set up a radio station on Long Island and in the early part of 1915 they actually telephoned from there to the Dupont Building at Wilmington, Del.

The experimenters were then convinced that it was possible to transmit conversations by radio over very great distances and in the latter part of 1915 they talked from Arlington Naval Station in Washington to Panama, to San Francisco, to Honolulu and later to the Eiffel Tower in Paris.

-30-

**TECHNICAL BOOK  
& BULLETIN REVIEW**

"MICROWAVE TRANSMISSION," by J. C. Slater, Professor of Physics, Massachusetts Institute of Technology. Published by McGraw-Hill Book Co., Inc., 330 W. 42nd St., New York City. 304 pp. plus index. Price, \$3.50.

In this new book, the author steers a middle course between very elementary and very advanced stands; between the highly theoretical and the completely practical. Microwaves are treated both from the standpoint of conventional transmission lines and of Maxwell's equations. It is the first book of its kind on ultra-high-frequency systems.

Microwave transmission is such a new subject that the workers in the field, as well as students, should be interested in a book like the present one, bringing together considerable material that has been developed largely during the last ten years and is now available only in the theoretical literature such as the *Proceedings of the Institute of Radio Engineers*, etc.

The adoption of microwaves for wartime use has aided and is aiding materially our war effort to a marked degree. New systems have been involved whereby these extremely short waves contribute to entirely new techniques in radio communications and associated applications. Students and engineers will benefit by adding this important book to their libraries.

"A-C CALCULATION CHARTS," by R. Lorenzen. Published by John F. Rider Publishing, Inc., 404 Fourth Avenue, New York City. Price, \$7.50.

Here is a tremendous time saver for engineers and others who work on electrical communications and electrical power problems. It covers all alternating current calculations on series circuits, parallel circuits, series-parallel and mesh circuits, at frequencies from 10 cycles to 1,000 megacycles. There are 146 charts measuring 7x11" printed in two colors. The series of charts contained in the book are intended for purposes of making alternating current circuit calculations with a greater speed than was hitherto attainable. They were designed, together with supplementary scales accompanying them, with the purpose of reducing the time consumed in making electrical circuit computations.

This is one of the finest series of charts that we have had the pleasure of reviewing.

"ELECTRICAL FUNDAMENTALS OF EDUCATION," by Arthur L. Albert, Professor of Communication Engineering, Oregon State College. Published by McGraw-Hill Book Co., Inc., 330 W. 42nd St., New York City. 546 pp. plus index. Price, \$3.50.

This distinctive book deals with  
(Continued on page 81)



by **JERRY COLBY**

**A**NENT our recent remarks on the Aircraft Detection setup, we quote Lt. (jg) USNR Geo. E. Swartz, Acting Personnel Officer, Naval Training Station, Treasure Island, San Francisco, Cal., "In the first place you seem to be confused as to the difference between radio operator training and radio materiel training. The two are distinctly separate and are carried out by different schools. Operators school as its name implies is for training operators or "brass pounders" and would take care of those whose case seems to have given you your "peeve." On the other hand, radio materiel school is concerned with the training of "radio technicians" who are concerned with the engineering phase of the art and whose business is upkeep and repair of all types of radio equipment, including that for "Aircraft Detection."

... I will admit however that occasionally one who lacks proper qualifications will slip by the recruiting office but contrary to your apparent belief regarding this matter, these men are not set "on the beach" but are transferred to the operators school or to other rating where their abilities seem to indicate they will be useful. There have been a few cases where there was nothing in the Navy for a particular man's peculiar abilities and some of these have been given a choice of that or taking seaman rating and being retained in the service. Now, as to RADAR, that much misunderstood and misused word, it applies to one

particular type of apparatus used for one particular type of work and does not include the entire gamut of radio equipment as your use of the word seems to imply. Out of the entire eight month's course in radio materiel, Radar takes one month, the final month of the course. *Ed. Note: The term "RADAR" has been discontinued as a reference.*

The Navy's radio materiel course is divided into two parts, (1) a preliminary 3 months of prep school where the student gets a "brush-up" on his math and electrical theory and, (2) the advanced school where his math, etc., are applied to further study of theory and where he gets practical experience and training in shop and lab work on actual Navy equipment. The prep courses are conducted at different universities and colleges around the country and are taught by regular college professors and the instruction is distinctly of college level. The work of radio materiel covers the entire field of radio engineering in design, upkeep and repair of every conceivable type of radio transmitting, receiving and other equipment and is highly developed and complicated. So without the services of highly trained and capable personnel the Navy would be "out of luck" in battle or other emergency when everything may depend upon the proper and efficient functioning of the apparatus included under the heading of "radio materiel."

Please accept this as a friendly attempt to explain the true conditions and as no reflection on you, OM or "RN." Your column is one of the first things I look for when I receive my magazine each month and here's more power to your "pen."

We appreciate Lieut. Swartz's explicit explanation of the RADAR school setup which we believe will be of inestimable value to those "hams" who are desirous of enlisting in this special Navy setup. Government money and men's time will not be wantonly wasted when and if a man does get by a Recruiting Officer's eagle eye. *Tnx, OM.*



"Wise guy, Huh? So lightning won't affect the operation of an F.M. set!"

**W**HEN unsung heroes are mustered out the radiops of the Inspection Division, US Army Sig. Corps, will receive their just credit. These men are seeing to it that only the finest and most perfect material and  
(Continued on page 63)

# WHAT'S NEW IN RADIO

## Ball Measuring Anvil

The *George Scherr Company* has just developed a ball measuring anvil for use on the Scherr Comparitol designed to speed up, simplify and guarantee accuracy for the measurement of thin work. The inspection and measuring of extremely thin pieces, such as crystals, laminations, shims, extremely small gages and other flat work can now be accomplished rapidly and with accurate results.

The extreme thinness of this class of work makes it difficult, impractical and frequently impossible to obtain accurate readings in .0001" or .00005" by the use of the standard flat or serrated measuring anvil.

With the ball anvil the work is placed between the flat feeler point and the round ball surface and absolutely dependable results are obtained

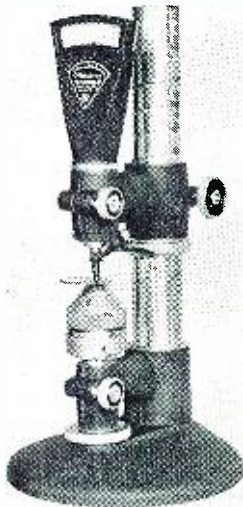

regardless of which part of the thin piece under inspection is being measured. All danger of distorting or bending the shim or lamination out of size a few ten-thousandths due to measuring pressure of the instrument is eliminated by the use of the measuring ball anvil.

Another outstanding feature is that with the use of the ball anvil the instrument may also be used to check the flatness or parallelism of long thin pieces in all positions and on all parts of the work. The Comparitol column when used with this ball anvil is provided with an index line so that the ball point and feeler point can be lined up accurately from left to right as to center distance.

This new development has solved a number of very difficult measuring problems involving the uses of extremely thin pieces. Full information may be obtained from the *George Scherr Co., Inc.*, 128 Lafayette Street, New York, N. Y.

## New Phonograph Needle

Peter L. Jensen, one of the country's foremost audio authorities, has recently marketed a new type of phonograph needle which may revolutionize the art.

"The peculiar design of this new needle," says Mr. Jensen, "was arrived at after a most painstaking period of careful research. It was our aim to produce a very long life needle which possessed the highest degree of fidelity, while, at the same time, reduced the scratch and the wear on the records to a minimum.

The compliance of the Jensen Concert Needle gives it a shock absorbing characteristic which permits it to glide along smoothly in the groove and also reduces materially the needle scratch.

By making the needle rigid in a cross-wise plane, all the frequencies in the record are transmitted without loss to the mechanism in the pick-up, but the flattened cross section causes less air to be agitated direct, and the result is a noticeable reduction in "needle talk." With this new type needle it is no longer necessary to close the top on the phonograph in order to eliminate the objectionable scratch, hiss and talk which emanates directly from the needle.

The needle point itself is made from an alloy of precious metals, but this particular alloy is made to have great wear-resisting qualities rather than extreme hardness.

The offices of the *Jensen Industries, Inc.*, are located at 737 North Michigan Avenue in Chicago.

## Ward Leonard Relays

*Ward Leonard Bulletin 104 Relays* are small compact remote control units adapted to applications within their ratings where space is limited.

These relays are available for operation on a.c. and d.c. circuits. Standard relays are of the open type, front connected solder type terminals, double pole, double throw, silver-to-silver contacts. Contacts are rated: 4 am-

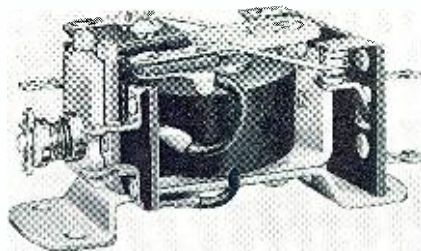

peres up to 24 volts a.c. or d.c. and 4 amperes a.c.; 1 ampere d.c. from 25 to 115 volts.

Bulletin 104 Relays are vibration re-

sistant up to ten times gravity in the energized position. The overall height from base to armature is 1¼ inches. Manufactured by the *Ward Leonard Electric Co.*, Mt. Vernon, N. Y.

## Recording Disc Container

One of the major problems in the transportation of recording discs has been the packaging of these discs in a way that will cut down breakage. *Gould-Moody* has long recognized the importance of this problem and now with an ingenuity and inventiveness

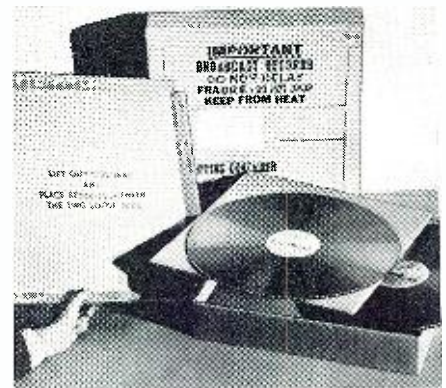

that is typical of this progressive Company they have developed **PacKARTON**. First of its kind!!

This recording disc shipping container eliminates the possibility of broken records . . . you can ship in absolute safety, and know beyond a shadow of a doubt that your records will reach their destination in the same perfect condition.

**PacKARTON** is made of a perfected, light-weight corrugated container that safeguards the shipment of delicate glass base records via air, railway or truck. Successful two-way shipping tests prove convincingly the value of suspension-cushioning principles utilized in **PacKARTON** construction . . . the record literally "floats on air" between its protective coverings.

**PacKARTON** is easy to handle, dustproof, needs no messy excelsior or paper wadding to prevent contents from sliding and reduces your shipping costs considerably.

For further information contact the *Gould-Moody Company*, 395 Broadway, New York City—Makers of Black Seal Glass Base Records.

## Large Victory Electric Clock

One of the latest developments in the way of time-keeping pieces to be evolved under stress of war-time conditions is the "VICTORY" **TELOMETER**.

This clock shows the time in numerals, time-table fashion, as —10:22,  
(Continued on page 80)

# ELECTRONIC DETECTIVES



"Electronic Cop" tells motorist how fast he is going. Electronic Timer does the trick.

THE Sherlock Holmes of yesterday trailed suspects in person, - peeped through keyholes, and sought criminal evidence in the chemical test-tube. Today, a fragile-looking radio or electronic tube, as if acting by proxy, is doing detective work more subtly and surely than any master sleuth. Not necessarily in the field of criminology, although electronics are playing a role as burglar alarms and foiling bank bandits, this new science is measuring the speed of automobiles, warning of ship smoke as a signal to Nazi submarines, detecting dross in metal mines, X-raying bad teeth, determining the diameter of a bubble, acting as smokestack spy, detecting faulty power lines, finding out when fruit is ripe and recovering magic dust.

Along a highway near St. Paul and Minneapolis, Minnesota, the eyes of motorists are abruptly focused on a signboard immediately ahead. It might be confused with an advertising sign for pleasure shaving, a breakfast food purporting the development of a Jack Dempsey or a Joe Louis, or an automobile oil that will perform every function except lift the car's hood. In reality, this illuminated signboard is America's first electronic highway patrol—the "Charlie McCarthy" in warn-

by SELDON SUMMERS

*The War situation has hastened the development and adoption of photo-cell units for the protection of property and as time-saving devices*

ing speeding automobile drivers. A mile away, the motorist who speeds may read the speed of his machine in large lighted numbers. If the motorist is traveling too fast for dangerous curves ahead, this sign flashes an additional warning, "Slow Down." The world's first electronic speed cop issues no summons, but the motorist is nonetheless bewildered at the behavior of this lighted-up robot. The science of electronics is the key to the puzzle—an automobile, passing a certain point on this highway, interrupts a beam of light, not visible to the naked eye. A photoelectric tube of the *General Electric Company* turns on the illuminated sign, at the same time starting an electronic timer, which measures the automobile's speed, with the precision of the speedometer on the instrument panel. As the automobile passes the second pho-

totube or "electric eye," the timer determines the speed, and this, in turn, is flashed in lights as a cautious warning to the motorist. Electrons, traveling with the celerity of light waves, flash their message in ample time to warn the fastest driver. One-millionth of a second to an electron is comparable to a man's life span. To argue with this electronic speed cop would be like disputing the exactness of the multiplication table.

As this article is being written a total of more than 250 Allied merchant ships have been sunk in American waters by enemy submarines. Blimps, the convoy system, patrol boats, and seaplanes have been employed to combat this menace, but ship sinkings continue at a reduced rate. As recent as August of this year, the *General Electric Company* introduced  
(Continued on page 54)



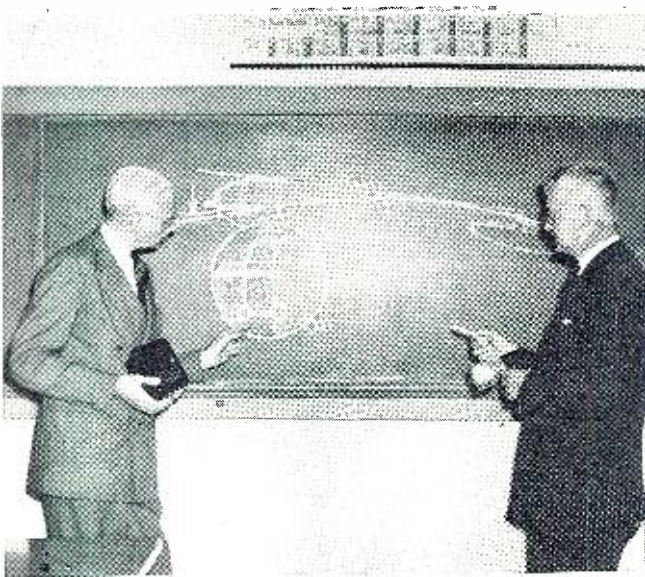

Dr. W. C. White, Director of G-E Electronics Lab, holds phototube holder and indicates where apparatus would be installed in ship.

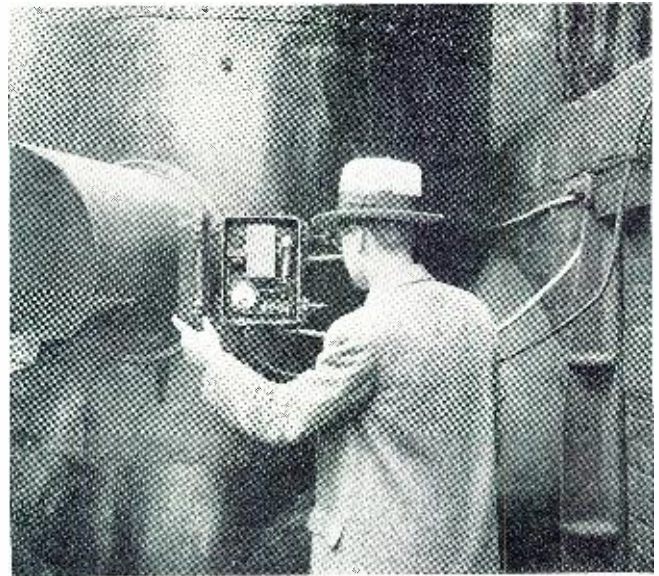

G-E photoelectric smoke-density recorder installed in a power house. It indicates the amount of smoke leaving the chimney.

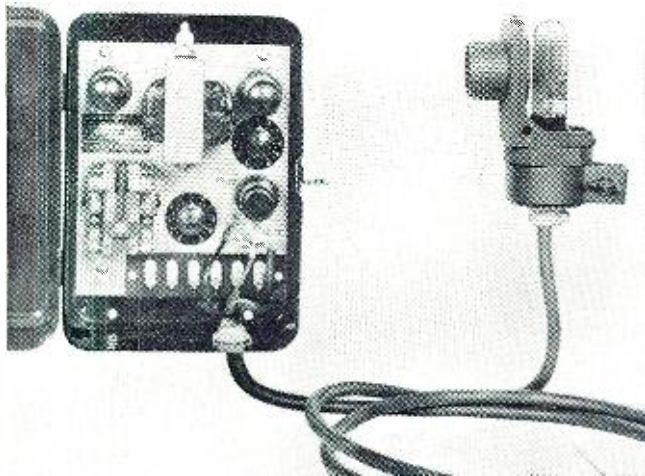

G-E photoelectric relay equipment. The two-unit assembly consists of the phototube holder and associated relay box.

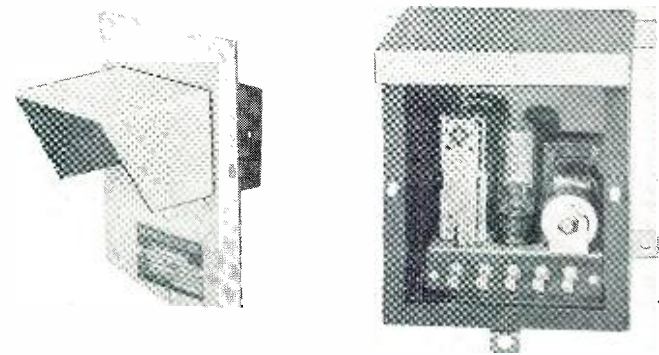

Midget photoelectric relay designed for outdoor use. It measures only 8" high, 8" wide, and approximately 10" deep.

Vibration system for testing ripeness of fruit. Vibration feed-back oscillator is used.

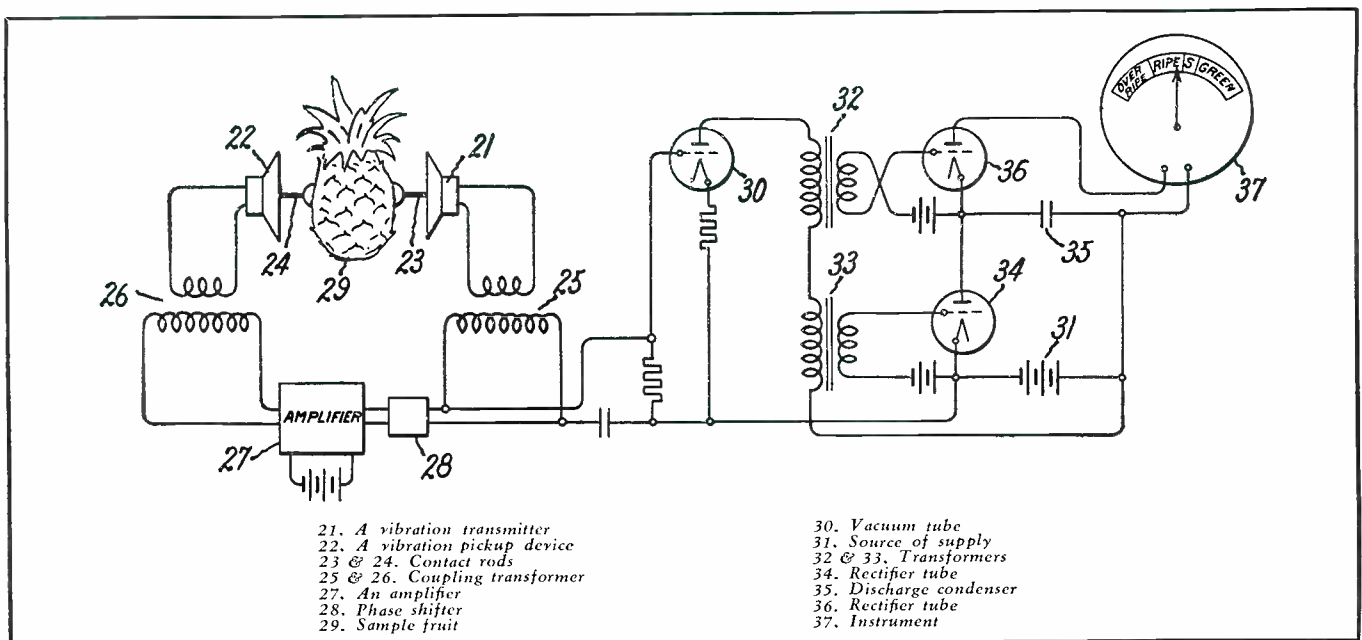

# INDUSTRIAL SOUND FOR WAR PRODUCTION

by **SIDNEY HARMAN** and **HASKEL A. BLAIR**

The David Bogen Co.

*Extensive and well-planned sound installations are playing a vital role in stepping up production and maintaining morale.*

THE employment of industrial sound equipment has kept pace with the ceaseless growth of American war industry. Historically, its development has been somewhat unusual. Prior to the war, many large plants were using standard microphone-amplifier-speaker systems for paging calls to some work sections and others had actually developed extensive systems which covered many square blocks. These systems were, however, extremely simple in design and naturally, very limited in function.

With the outbreak of war and with the new necessity for maximum speed—maximum efficiency—maximum production, a number of the country's

largest plants began to investigate the values of larger sound systems which could be employed to "reach every corner of the factory and office," which could issue not only paging calls, but various types of alarms and signals, and which could be designed for the multiple types of operation described in previous articles. The earliest special systems used were the product of conversations between management of the really large plants and David Bogen sound engineers. The systems which resulted were extensive and complex. Therefore, the development was essentially from the very simple and limited system to the very complex and expansive one.

The tremendous success which the

manufacturers of airplanes, for example, experienced with this new type of equipment, the very obvious boost in workers' morale and the resultant increase in efficiency and production created wide interest on the part of many smaller manufacturers who feared that the equipment was more than they could handle.

The simple fact that the same functions, the same type of operation and the same results could be achieved in smaller systems has resulted in the widespread use of custom-built industrial sound equipment in medium and smaller sized war plants throughout the country.

This article concerns itself with a system specially designed and manu-

Basic block diagram of the specially-engineered system described.

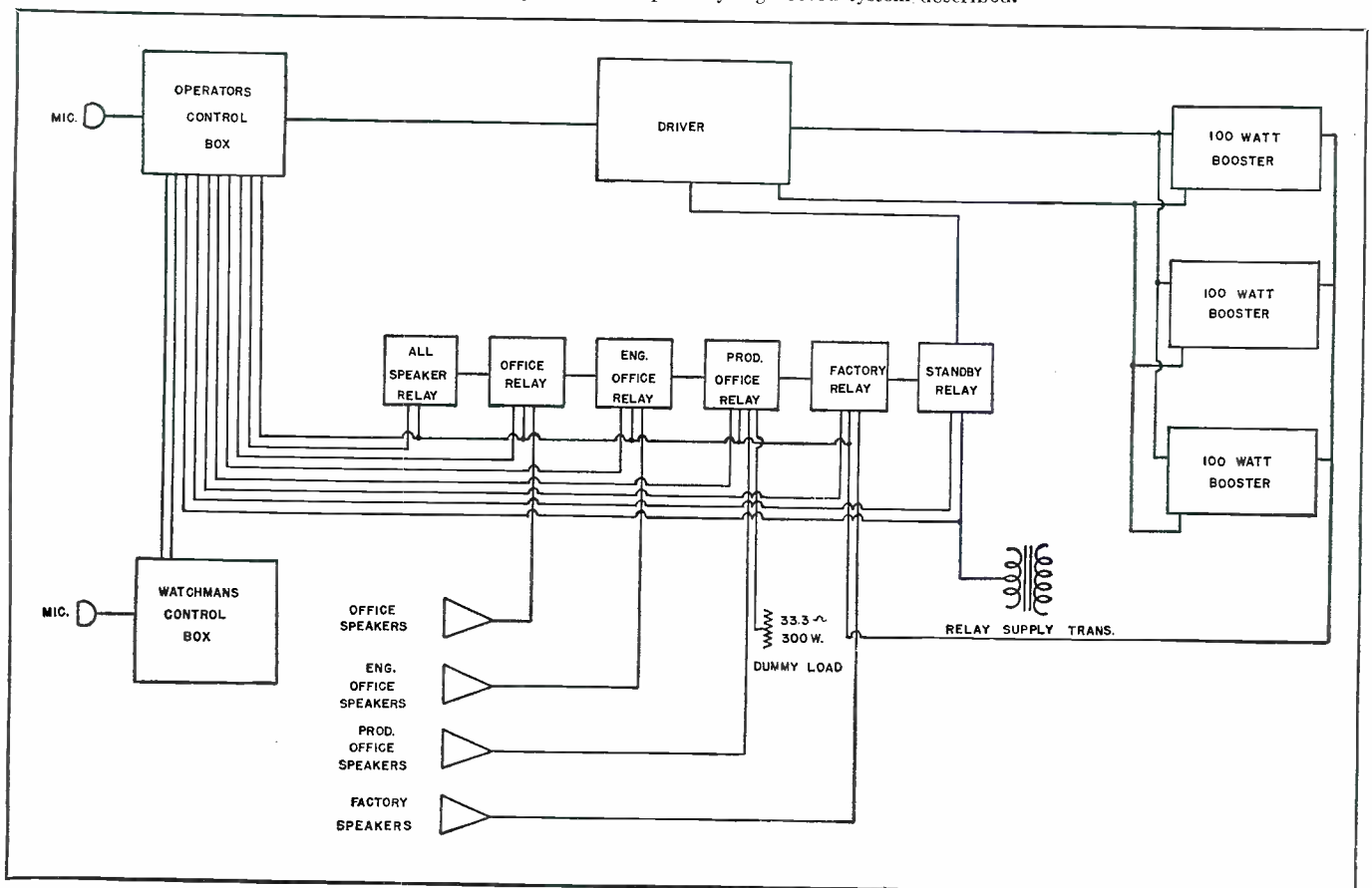

factured for a plant manufacturing galleys for ships of the U. S. Navy and sterilizers for Army hospitals and Navy hospital ships. The plant consists of three connected buildings, each three stories high and extending approximately 350 feet long by 225 feet wide.

Monel and stainless steel are used for production and the operation of high powered punching and stamping machines created severely high noise levels. This level was more than 100 db. in some areas (a level so high that a man can only be heard when he shouts into another's ear).

A system of bells and gongs had originally been used for paging purposes (a series of bells indicating that a given party was being sought or that a telephone call had come in, etc.). Ten and twelve inch bells which under normal conditions could be heard for a number of square blocks were used, but the bells and gongs synchronized so accurately with the sound of the metals as they were stamped and pinched that it was practically impossible to distinguish the signal from the normal plant noise.

The original intention had been, then, to substitute a voice system for the bell system. When it was pointed out that calls could be distributed to limited areas so that it would be unnecessary to issue the announcement to the complete plant, if the man required were known to be definitely in the Production Office, the management requested that the system be designed so that selection of: (1) Office, (2) Engineering Office, (3) Production Office, and (4) Factory, could be accomplished.

It was further decided, since the plant was operating twenty-four hours a day, that control of the system should be turned over to the watchman when the office staff including the telephone operator left for the day. This would permit emergency and paging announcements to be made by the watchman, and would satisfy OCD requirements relative to the issuance of alarm notices.

Again, since the equipment was to be used 24 hours a day, it was recognized that some precaution should be taken to minimize the heat dissipated and to reduce the current drain. A stand-by position was therefore incorporated, which operated in such manner that when the telephone operator pressed her talk switch, a relay would be activated closing the plate supply circuit and furnishing the correct voltages to the plates of all tubes. A separate switch was also provided at the watchman's station to control stand-by. The filaments of all tubes were always at operating temperature and therefore no delay resulted from waiting for tubes to "heat up" when a call was to be made.

Reference to the functional diagram will show how the system finally decided upon operated. It will be seen that separate relays controlled the various speaker loops, the first of which

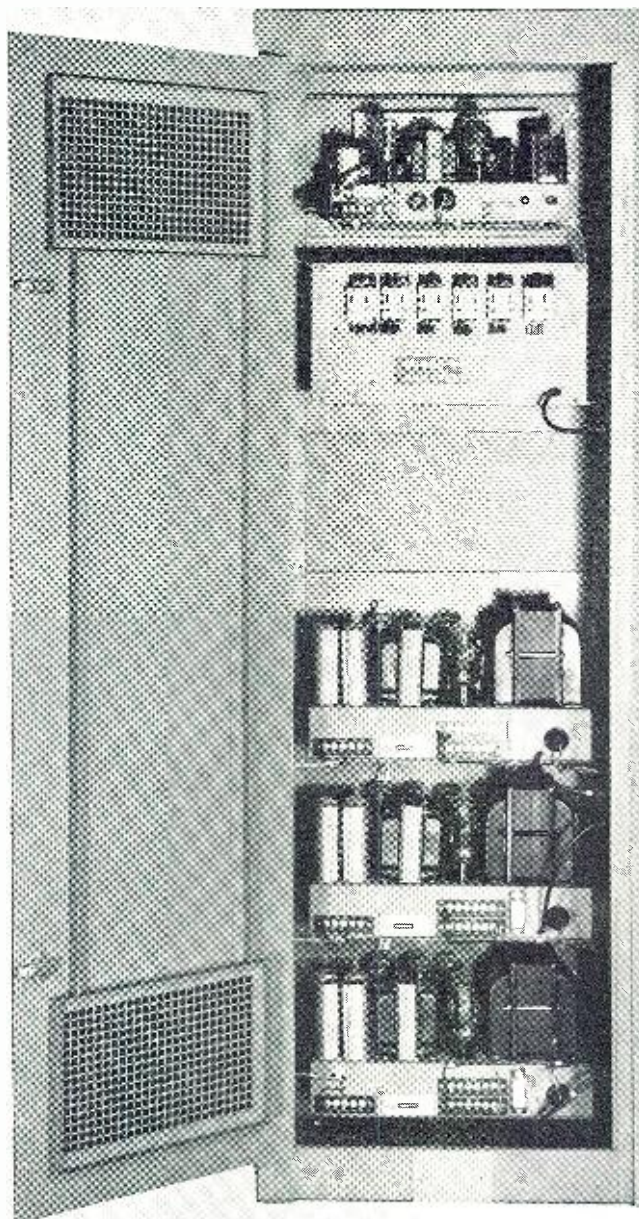

Rear view of Central Control Rack shows driver, relay panel and boosters.

tied all speakers into the output of the booster amplifiers, the second controlled the Office speakers only, and the third controlled the speakers in the Engineers' Office, etc.

The standby relay supplies 24 volts to operate the plate supply relay in each amplifier. The system has a total output of 300 watts of audio power and we shall discuss how this figure was achieved later in the article. A 33 ohm line was run by paralleling the 100 ohm output taps of the output transformers of each booster amplifier. The major portion of the speakers and, therefore, the major load on the amplifiers were the factory speakers. It can be seen that if no provision were made to dummy-load the output of the amplifiers when a group of speakers other than those in the factory were called, the power fed to the speakers called would be extremely high. It would then be neces-

sary for the operator at the control rack to attenuate the volume control, and should the next call be sent to the factory only, the level would be so low that it would be barely audible above the exceptionally high noise of the factory itself. To prevent such a condition, a dummy load of  $33\frac{1}{3}$  ohms—300 watts is automatically thrown in whenever the factory relay is open. Thus, if a call is sent to the other speakers, a load equivalent to that of the factory speakers is thrown into the line. Since there are so few other speakers in the system and since they, therefore, present so small a portion of the load to the amplifiers, it is unnecessary to provide dummy loads for them.

The rear view of the central control rack shows the driver amplifier providing a low impedance input for the local and watchman's control station.

(Continued on page 73)

# Spot Radio News

**I N D E F E N S E A N D I N D U S T R Y**

*Presenting latest information on the Radio situation.*

by **LEWIS WINNER**

RADIO NEWS WASHINGTON CORRESPONDENT

THEY MAY DEFER MANY RADIO SERVICE men permanently in England. The decisions depend on the results of negotiations between the Radio Manufacturers' Association and the Ministry of Labor who are attempting to establish minimum radio servicing facilities throughout the country for the period of the war. In the announcement that is expected, the basis upon which the service engineers may be granted deferment in sufficient numbers to afford servicing at an agreed level, will be defined. The negotiations between the association and the Ministry on this problem began the early part of this year. At that time a questionnaire was sent to all of those in the radio industry, at the suggestion of six of the radio associations in England. The information asked for concerned the amount of service work undertaken, the number of service men employed and so on. Pending establishment of an agreed system, the Ministry of Labor arranged temporarily to suspend the calling of such men, so that in the interim period the industry would not be entirely stripped of its remaining reserves of skilled help.

FIRE WHICH IS QUITE RARE at transmitters, broke out recently at the WLAY station in Muscle Shoals City, Alabama, and destroyed the equipment so completely that a new unit had to be sought. The FCC, granted the company a permit to install a new transmitter. This action is of unusual importance since it is the first of its type since the announcement of the war rulings, barring construction permits except in instances of fire, flood, or the like.

AIR RAID WARNINGS by way of the house power line are now possible, thanks to the device developed by J. L. Woodworth of *General Electric*. It is designed to operate on the 720 cycle carrier current systems now in operation on power lines in many cities, and in so doing affords both visible and audible warning signals. Carrier current, it will be recalled, was used quite effectively in establishing wired radio and then a variety of intercommunication systems. Because of many innate problems its development was discontinued for awhile. Development was begun again and today we have many transmission systems using carrier current methods. In many cities, for instance, carrier current is used to

control water heaters and street lights. And in power development areas, carrier current is used for voice transmission, with radio-type receivers used to pick up the signals.

This newest device is operated by a control board attached to the carrier current transmitter at the power station. By means of this board, the four raid signals can be sent over the lines. When one of these signals is received by the device, a warning buzzer sounds. The same signal also starts a motor driven selector, which begins rotating a small transparent plastic dial divided into four colored sections . . . white, red, blue and yellow. This dial turns, until the proper colored section corresponding to the signal sent from headquarters appears opposite a small window in the cover of the device. A small 110 volt lamp, behind the dial and window, provides the illumination to make visible the colored signal, the yellow being for preliminary caution, blue for advance caution, red for a raid and white for all clear. The inventor says that the board can also transmit signals to operate sirens, fire whistles, traffic lights, etc. It doesn't look as if carrier current development will slow down, now, with such innovations as this new one being made available!

THERE'S A DEEP GLOOM OVER MANY a shop and home where there are battery-portable radios today! For the WPB has curbed all production on the

batteries for these sets. As a matter of fact, only 35% of the quantity of radio batteries produced in 1941 will be manufactured. And these will be primarily for use on farm sets. The WPB says that the battery for the portable type of radio is non-essential. Fortunately there is a pretty good stock of batteries on the dealers' shelves. But we all know that batteries don't have an indefinite life, even if they aren't in use, and so when they're gone . . . well . . . it'll be the a.c. or d.c. line for current, or else there'll be no radio.

A BREATHLESS DEMONSTRATION AND TEST of the effectiveness of civilian defense organizations was enacted recently during the Potomac River flood at Washington, D. C. All members of the staffs of the groups of defense units in the District of Columbia, Maryland and Virginia areas pitched in, serving right along with police, firemen and soldiers, taking the same risks, doing the same back-breaking tasks to rescue lives and property. And as usual radio played its vital role, coordinating the activities of the various communities, with broadcast stations carrying much of the communications traffic. Point-to-point traffic was also maintained effectively by the portable and mobile units of the various agencies. Unfortunately the "war emergency radio service" network manned by amateurs and other volunteer operators was not in full swing during this period. The need for such an assisting communications-service was quite evident. However those services available aided admirably. In addition, data was collected on emergency communications problems that will be of invaluable service for the emergency networks when they are placed in full operation.

THE A'S HAVE IT in the house of priorities and with a vengeance. Starting at triple A, to double A from one to ten, and just the little a's, we find the A's in full swing. The double and triple A's were adopted, you will recall, when it was found that the original single A classification was insufficient. In the triple A classification we have those products that are "musts" in our production plan. In the AA-1 through AA-4 (and recently a AA-5 member has also been added), we have many military and many essential non-military items. Those items which have had the old high in priority ratings



Huge porcelain insulators used for the War effort in radio services.

such as A-1, must have the double AA rating now, to rate, at least, the same concern.

While many new priority ratings have been given to materials heretofore, in the lower brackets, even those high ratings are not helping in view of some bottlenecks of production, and shortages of materials. This is not so prevalent in the heavier industry as in the lighter industries, with radio as a glowing example. As a result many manufacturers are unable, for example, to supply replacement parts in the quantities planned. This is an unavoidable condition and should be appreciated by those who service. And unfortunately there is little that can be done, except to be tolerant and attempt to use every other means, including substitution methods, until help does come, in the way of the requested part. War has the bad habit of devouring those materials, we happen to need in radio, too!

**WHO SAID BROADCASTING** wasn't playing an important role today? The *Office of War Information* can't be the guilty ones . . . for they have just arranged for the purchase of eight hours of programs daily from the three major networks. The programs will be piped from San Francisco to the four Alaskan stations at Fairbanks (KFAR), Juneau (KINY), Ketchikan (KTKN) and Anchorage (KFQD) and then rebroadcast. Included in these programs will be news, special programs and some commercial shows. As equipment becomes available, the OWI, in conjunction with the Signal Corps, will install low powered transmitters at Nome, Dutch Harbor and Kodiak, so that our boys there, will also be able to hear programs from back home.

**WE SAID AWHILE AGO** that copper was more than worth its weight in gold, and now it seems as if that comment was more than justified, for they've stopped mining gold so that they can mine more copper! Says the War Manpower Commission in comment on this WPB limitation order . . . "Every gold worker who transfers to copper, aluminum, zinc and other non-ferrous activities is contributing to the war effort. One miner can add almost four tons of refined copper per month to the nation's output."

Gold's companion, silver, is also contributing to the war effort, although in a different manner. Twenty-four million pounds of copper have been saved in the last few months by substituting silver for copper as an electrical conductor. As we pointed out some time ago, a minimum of 34,000 tons of silver has been allotted to the *Defense Plant Corporation* by the United States Treasury. The silver is, of course, being loaned, for it must be returned after the war. Thus only those plants that are using the metal for conducting purposes, and not for consuming purposes will get silver, so

don't expect to see silver knick-knacks in the five and ten, but don't be surprised to see nice, shiny silver bus bars if you visit a power plant or communications system.

**THE MUNICIPAL STATION OF NEW YORK CITY** hopes to join the growing list of F-M transmitters. They expect that their station W39NY should be in full operation in November. With this addition, there will be nine F-M units in operation in New York City, including W75NY that has just begun operating. This latter station is controlled by two of New York's larger department stores, and is expected to introduce innovations in broadcast technique that will set new standards of operation. And talking about innovations, Chicago's F-M station W75C, the A-M parent of WMBI, will be the first in this city to use the effective ST link (studio-to-transmitter link via an ultra-short wave low powered transmitter). The studios are in Chicago, but the transmitting site is in Addison, Ill., which is nineteen miles westward.

**ANTICIPATING THE INFLUX OF WOMEN** engineers, Carl Lee, chief engineer of WKZO, Kalamazoo, has developed a condensed lightweight remote amplifier. Even a baby can carry it and even a baby can operate it, he says. Incidentally he's named the amplifier . . . the 4F . . . in honor of the 4F engineers who might be operating it . . . at least until the women come in. Wonder what he'll name it then!

**ALTHOUGH MATERIALS ARE SCARCE** AND priorities have curbed many enterprises in Canada, radio has managed to flaunt its golden head and win an \$800,000 high power short station that will eventually be installed in New Brunswick. In approving the construction of the station, the Order-in-Council said that the station will be able to provide the "essential means of self defense and counter-attack

against the continuous flow of German and Italian short wave propaganda directed to Canada or transmitted to foreign countries in order to minimize the Canadian war effort." The station will be used to fight hard, the authorities say. The "self-defense and counter-attack" may be done "positively by our own short wave programs or negatively by jamming harmful incoming programs from enemy or enemy-occupied countries", say the officials.

Two 50 kilowatt transmitters will be used, with three directional antennae. The Dominion Government, and not the CBC will own the station, although the CBC will operate it in working in consultation with the *External Affairs Department*.

Our Government is not overlooking the possibilities of short wave broadcasts either. Every effort is now being made to clear the path for the construction of several more high powered units, notwithstanding the shortages of materials. There is every indication that somehow the materials will be made available so that these additional stations can start waving away at our enemies. The present short wave facilities are already being loaned to the Government so that the mightiest propaganda campaign can be waged. In the original plan for additional stations, twenty were asked for, and thus far it appears as if half, if not more, may be constructed.

**A MAKESHIFT METHOD OF TRANSMISSION** guided two lost bombers to safety in the monsoon swept regions of China recently. A piece of wire strung from a grounded plane to a car did it . . . and to Private Arthur W. Roderick, of Vincennes, Indiana, an air transport command radio operator, goes the credit for the doing. Returning from a mission in the face of dangerous weather, several B-25 medium bombers became lost and were unable to make radio contact. Realizing that the planes could not find the base, Private Roderick rigged his homing device and made contact with the planes, enabling them to fly to safety.

**SPARK SUPPRESSION IN CAR RADIOS** has always been a major problem, particularly in those mobile units using two-way systems. A new development, prompted by the use of two-way communications in tanks, jeeps and half-tracks, now seems to have solved that problem effectively. The difficulty was overcome by *Willys-Overland Motors* engineers, in close cooperation with the *Signal Corps*, with the aid of filters and suppressors that really work. Tests, according to Delmar G. Roos, chief engineer of the company, and actual use during the past six months have proven its effectiveness, under the most adverse of conditions. What a boon this will be to the post-war automobile. Yes, and what a boon hundreds of developments similar to this one, now being born in the laboratories of the Nation, will be to other post-war activities.

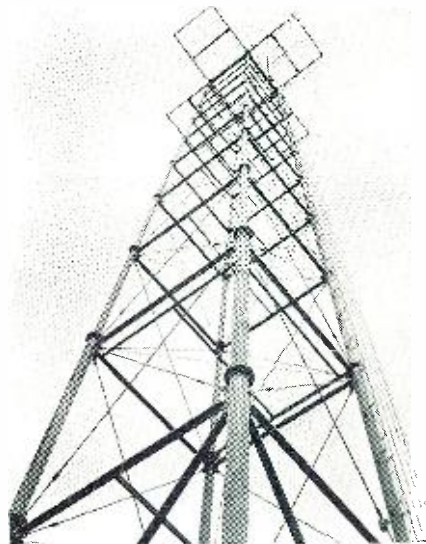

Lack of steel and iron used in antenna towers will limit future construction.

**THOSE UNIQUE THROAT MICROPHONES**, originally developed for use aboard the plane for ground-to-plane contact, are now being used in other places where noise is also the disturbing factor, as is in planes. The latest area for its installation is in the welding classrooms of the *Curtiss-Wright Corporation*, where before the use of these microphones, it was necessary for the instructor to shout instructions. The public address system was of no avail, since the noise was still too great, particularly so since a great deal of the instruction is individual. Now the students wear earphones, and the instructors can talk in a normal tone, by way of the throat microphone. Either a direct wire audio frequency method or ultra-high-frequency method of communication is effective with this new system. The use of the hearing aid system is also appropriate, although in this way extraneous noises, deliberately destroyed by the throat mike, are again picked up and amplified along with the signal.

**NO MORE AMATEUR STATION LICENSES WILL BE ISSUED** until further notice, the FCC has recently ruled. This action has been taken in view of the many difficult administrative problems which have arisen in association with the granting of licenses since the beginning of war. Inasmuch as many licensees are in the military services or engaged in war industries in various parts of the country, it is impossible for such station licensees to exercise proper control of their transmitting apparatus and the control of the apartment or home where the equipment is located, in full accordance with the law. Now, with the establishment of the *War Emergency Radio Service*, the need for amateur equipment will only be necessary as the *Office of Civilian Defense* decrees it. And in this instance, proper licenses and operating authority will be granted, not only to those amateurs who may be selected to conduct such a service, but to others familiar with operating.

The Commission will continue its policy in regard to the issuance of new and renewed licenses or modification of such licenses for change in operator privileges. The holder of an amateur operator license desiring to maintain his amateur status should submit his application for amateur operator and amateur station license renewal in accordance with the rules. The Commission has also ruled that insofar as it is possible and practicable to do so, the call letters of outstanding amateur station licenses will be reserved for assignment to the present station licensee upon proper application when licensing of stations is resumed.

**DISTRIBUTORS WILL HEREAFTER HAVE** to use the PD-1X forms, if they wish to replenish their stocks. This form was originally issued some months ago to help distributors maintain a balanced stock of replacement

parts. Unfortunately most distributors did not use the form, and thus Washington has found it necessary to make the ruling mandatory. The order known as L-183, restricts the sale by a manufacturer of any replacement part to a distributor, wholesaler or jobber, unless those orders carry an A-3 or high priority rating. And this can only be achieved if the PD-1X is used. These ratings will be assigned to those parts listed on the form.

**IT'S "GRAMAPHONE" RECORD SALVAGE TIME** in England too. A country-wide campaign to salvage at least ten million old and unwanted records was in full swing for a month. And not only did the salvage departments benefit, but the British Legion and Hospital for Sick Children in London, too. For they were given the funds acquired from the sale of the salvaged records to the industry.

To give the campaign widest publicity, an intensive press and radio campaign was conducted. The public was asked to turn over their records to the local British Legion branch. So that the records could be packed for forwarding, dealers were asked to keep all record boxes and packing material for the repacking of these salvage records. Gramophone record dealers, in England, Scotland and Wales cooperated in the campaign, with huge posters and streamers displayed throughout their stores.

**OVER A MILLION HOME RADIOS** would be needed for consumption within the first six months if the war should end now, said the *United States Chamber of Commerce* recently in its report on the post-war market. This estimate was based on a national survey of family needs. In addition the survey also showed that 3.4 of every ten home owners plan to make repairs and improvements, with radio as one of major factors in this program, thus indicating the huge need for parts and accessories that will also exist. And that's the report now. What will it



Using the Spectograph to assist in the analysis of metals and minerals.

be six months from now? Kind of astronomical . . . it appears!

**IN CHICAGO THEY DEVOTED** a whole week, awhile ago, towards a city-wide collection of old and run-down sets. Chicagoans who counted radio sets, no matter in what condition, among their surplus possessions, were urged to contact the local civilian defense headquarters. The request for this round-up was made by the Army Air Force Technical School. They wanted old, outdated and obsolete receiving sets for use in laboratory instruction. The campaign keynote was struck by Mayor Kelly who presented Brig. Gen. Arnold N. Krogstad, commandant of the Chicago school, with the first receiver collected for that purpose.

Similar round-ups are planned for other centers where large training schools have been instituted. And not only is the Army interested in this collection campaign, but the Navy too, who have been increasing their training facilities rapidly.

If you have an old receiver, get it ready for the collection. And if you'd like to be on the jump a bit, send it on to one of the radio training schools that the Army or Navy has set up. Ask your local office for addresses.

**THE FAMOUS ORDER L-44** that prohibited radio set manufacture, has gained a neighbor order . . . L-183 . . . that provides that no one may manufacture, fabricate, assemble, or produce electronic devices, from microphones to antennae, in excess of a minimum inventory required to meet deliveries on orders rated at A-3 or higher. And inventories are permitted to a 45 day total supply, but may not in any case exceed 12½% of the total 1941 sales.

This new ruling does not however make a change in the manner in which a person may buy replacement tubes and parts for his home receiver. No rated order is necessary here. However distributors of such parts must use that PD-1X form as we stated in some other paragraphs, to obtain these replacement parts.

Exempted also from the ruling are electronic equipment used in hearing aids, telephone and telegraphic equipment, medical and therapeutic apparatus, and light and power components.

**THEY DON'T LIKE BATTERY SETS IN SCOTLAND** anymore. For there has been a marked decrease in purchases, notwithstanding price decreases, and the fact that batteries required to run the receivers are now relatively more plentiful. The shortage of batteries months ago seems to have started the disinterest. And now those who have battery sets are dismantling them and using the parts to either build line powered sets or donate the parts to those sources where shortages are apparent.

**IF YOU HAVE A SHORT WAVE RECEIVER AND LISTEN-IN** to Japanese broadcasts, you should get that new  
(Continued on page 50)

**ATTENTION—AMATEURS!**  
**FOR SALE**  
**QUANTITY OF**  
**SEEBURG DELUXE**  
**AUTOMATIC RECORD CHANGER**  
*and*  
**HOME RECORDER**

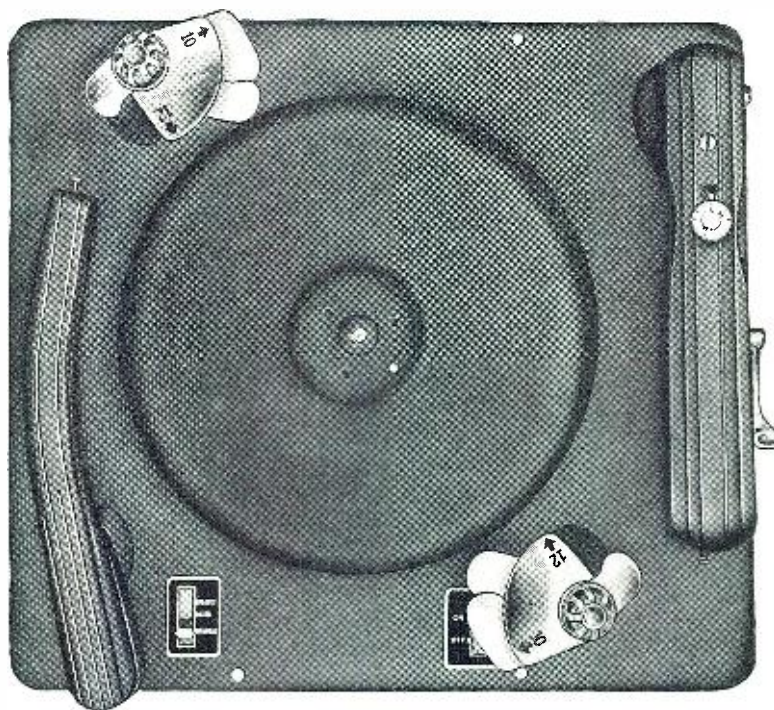

**Model No. BR 29 (for AC only)**

These are brand new units in original factory cartons. They are completely equipped including mounting bolts and coil spring supports, and each unit has an elaborate instruction booklet. But the units are minus needles and AC and pick-up wires which can be attached quite simply. Terms of payment are by money order or certified check accompanying each order.

*This offer is being made subject to prior sale.*

**PRICE \$29<sup>95</sup>**  
**ea., net cash**

**F.O.B. our warehouse in N. Y. City**  
**Approximate Retail Value \$95.00**

**COLEN-GRUHN CO., Inc., 387 Fourth Ave., New York, N. Y.**

# EQUIPMENT FOR FOREST DEFENSE

[See Front Cover]

by S. R. WINTERS

**Many innovations in design are required by the Forest Service to attain extremely light weight and flexibility for all of their portable units**

▶ TWO types of radio equipment which have proved to be both practical and reliable in the United States Forest Service's increasing endeavor to safeguard U. S. timber, are the type SX radiophone (UHF) Model A, and type M radiophone, Model D.

The type SX radiophone is a stabilized unit having extreme flexibility in application. It is a portable radiophone with self-contained batteries, applicable to uses of scouts, smokechasers, and others requiring extreme portability. The addition of the type SXA radiophone attachment, which incorporates a loudspeaker, adapts the unit to semi-portable service in lookouts, ranger stations, and wherever standby operation is needed. The type SX in the portable form supersedes the type S, and with the attachment supersedes the type SV, formerly used.

Type SX transmits and receives voice only. The portable unit weighs about 10 pounds, and has a rated working range of about 50 miles over optical paths. With low antennas and over level terrain, however, this may be reduced to 3 or 4 miles. A panel switch permits selection of any of 3 transmitting frequencies, any or all of which may be crystal controlled. The receiver is substantially non-radiating.

The provision for selecting any of 3 crystal-controlled frequencies adapts the unit for operation in fixed-frequency networks, and permits ready transfer from one network to another. The procedure for establishing communication is far simpler than for the older types, S and SV. A panel push button provides means for setting the receiver on any of the 3 transmitter frequencies.

Where strictly portable operation is contemplated, the radiophone is normally used without the attachment. The type SXA radiophone attachment is desirable where standby service is needed, since its amplifier and loudspeaker relieve the operator of the necessity of wearing headphones. No

additional wiring or mechanical change is required to install the attachment. It is necessary merely to remove the microphone and battery-cable plugs from the radiophone and to insert them into receptacles on the attachment. Short stub cords on the attachment are then plugged into the radio receptacles.

When the attachment is used with the radiophone, a kitbox is usually found to be convenient. This kitbox has compartments for storing the radiophone, radiophone attachment, heavy-duty batteries, heavy-duty battery cable, type J antenna, and hal-yards.

The type M radiophone is the highest power fire communication unit used by the Forest Service. It has a nominal output of 25 watts, although the full output is seldom used. It operates from an a.c. power supply or portable generator. The complete unit weighs about 90 pounds. The tube line-up is: 6F6G oscillator, two 6L6G in parallel in radio-frequency amplifier, 6F6G speech amplifier, push-pull 6L6G modulators, and a pair of 83 rectifiers.

A low-drift crystal maintains frequency stability. The output stage terminates in a pi matching network to accommodate a wide range of antenna or transmission line impedances.

The receiver section is a conventional superheterodyne having a minimum of operating controls.

The type M was designed for use at forest headquarters, central fire dispatchers, central equipment depots and at communication centers on large fires. Since these radiophones may be expected to create interference over a radius of several hundred miles, lower-powered units are substituted wherever possible.

A smaller unit of similar form designed to operate from an ordinary six-volt automobile storage battery is also available. This unit has an output of 9½ watts and is a substitute for the type M where commercial power is available and where, because of

"standby" requirements or for other reasons, it is not desirable to use a gas-engine-driven portable generator.

Type M radiophone, Model D, is a voice or code transmitter-receiver operating from 110 or 120 volts a.c. only, and has a rated working range of 50 miles. Designed for communication with the field from supervisors' headquarters and central equipment depots, type M radiophone is used mainly as a central communication station on large project fires.

The current type is a new design intended to minimize bulk and weight and to facilitate inspection and maintenance. The receiver portion of the radiophone is a sensitive superheterodyne having a normal tuning range of 2900 to 3500 kilocycles.

Although not designed for mobile operation, these units have been operated in planes, boats, and trucks where mobile equipment was not available.

All Forest Service radiophones operate in two groups of assigned frequencies. The high-frequency group includes frequencies between 2900 and 3500 kilocycles, and the ultra-high-frequency group includes frequencies between 32 and 39 megacycles (32,000 and 39,000 kilocycles). The various types of radiophones are divided into two groups according to the frequency range in which they are intended to operate.

Ultra-high-frequencies have the limitation of being good only over optical, or nearly optical, ranges. For example, usually it is not possible to communicate between two points when the optical path between the antennas at the respective stations is obstructed by a hill or mountain. On the other hand, when the Forest Service members find it possible to use UHF equipment, they report that it offers many advantages over the ordinary high-frequency radio equipment.

There is practically no fading or static; the equipment can be made quite light and compact; the antenna is short, being of the order of 15 feet;

(Continued on page 58)



## THE FUTURE OF TELEVISION

★ ★ ★

**T**HE future of the theater, screen and radio is so definitely linked with television that their destiny comprises chapters in a new book, "The Future of Television" by Orrin E. Dunlap, Jr., published by *Harper & Brothers*. Television will be one of the great post-war industries, says Mr. Dunlap. It will exert far-reaching influences on entertainment, education, the dissemination of news, sports, advertising, and the arts. Television is being greatly perfected by wartime research and engineering in radio and electron optics. That achievement will be an outstanding contribution of science to the new era promised by the Atlantic Charter. Sightseeing by radio is predicted as a national pastime. Homes everywhere will have all-seeing eyes, because the science of electronics will put television within the price-range of the masses, as it has radio sets. Just as transatlantic liners took on radio voices after World War I, so transatlantic planes will see by radio after World War II, while millions of people in their homes will look in on distant cities, across continents and seas. Radio, which made a whispering gallery of the heavens, is described as preparing to turn the world into a Hall of Mirrors. Reviewing the progress of television since it was officially launched at the New York World's Fair in 1939, Mr. Dunlap's book pursues a forward-looking theme. New importance is predicted for billboards in ballparks, as the television camera covering sports events sweeps across the big advertising signs to carry their messages to millions of distant spectators. Artist bureaus which manage singers and bands may be the promoters of

heavyweight champions when theater and home television turns the nation into a coast-to-coast sports arena. The main highway of radio progress, as Mr. Dunlap sees it, leads into the ultra-short wave spectrum and to micro-waves measured in centimeters. So significant is the promise of television in education that the author sees the "T" in teaching standing for television. Electronic television in color for the general public is something to look forward to, al-

though many problems are still to be overcome. Large pictures, at least 18 by 24 inches, definitely are in the offing for the home, and in the theater they will fill standard size screens. Whether television will take over Hollywood or Hollywood take over television remains an open question. Does television hover over the Broadway stage as a menace? Mr. Dunlap says: No. Just as the screen and radio have always turned to the stage for acts and actors, so will television. —30—

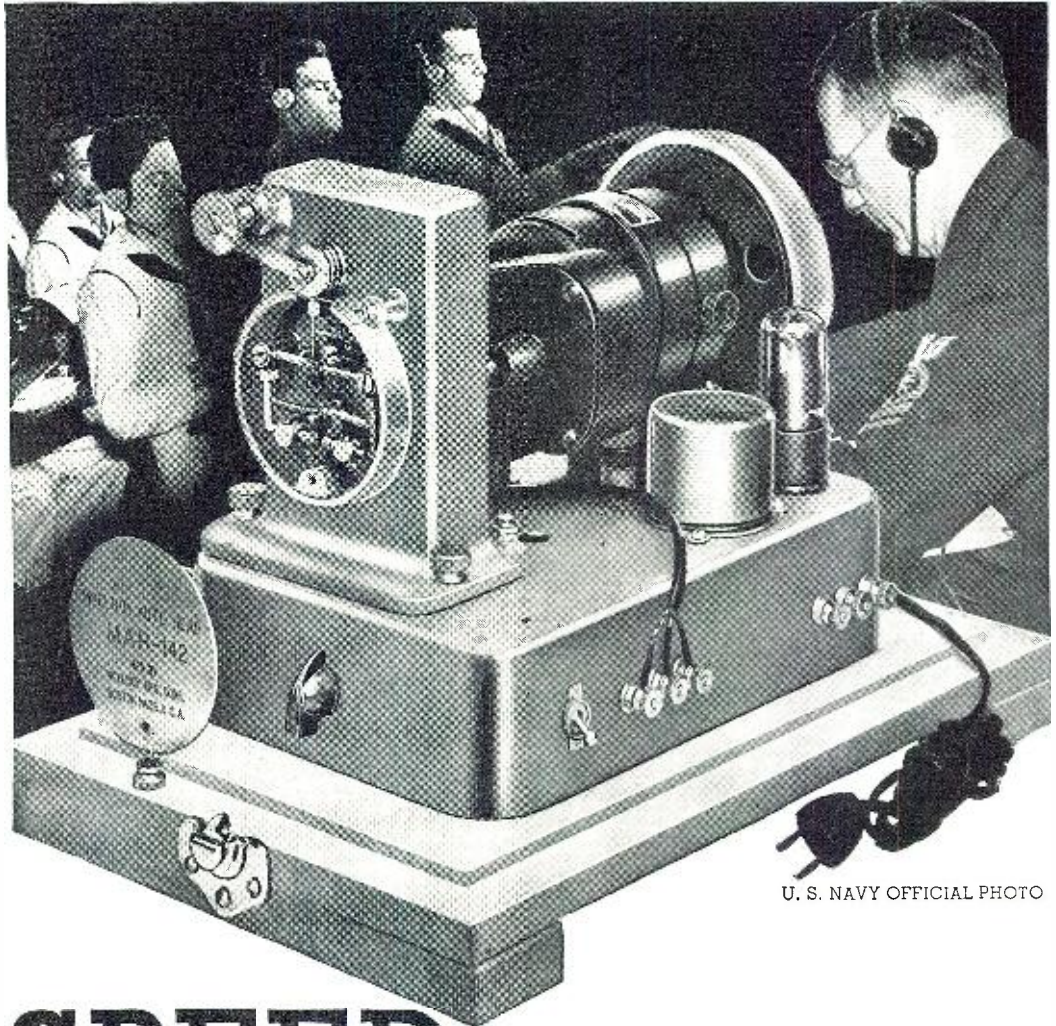

U. S. NAVY OFFICIAL PHOTO

## SPEED will save lives

That's why at McELROY, we're straining every effort, working to the limit of plant capacity in the design and production of precision-built telegraph equipment, engineered by the world champion telegraphist and outstanding wireless operator of all time.

Illustrated is our Model XTR-442 Transmitter, which may be set to operate at accurately controlled speeds ranging from 5 words per minute to as fast as 250 words per minute.

Our fighting forces need operators, now! McELROY equipment can train these men . . . fast!

**McELROY MANUFACTURING CORPORATION**  
82 BROOKLINE AVENUE BOSTON, MASSACHUSETTS

# SYLVANIA SERVICEMAN SERVICE

by  
**FRANK FAX**



**I**T'S no cinch for servicemen to keep the nation's radios in trim these days—with limited materials.

For our part, we're glad to do anything we can to make your task easier. As a matter of fact, many of you have been nice enough to say that you've found our Tube Simplification Chart and our Base Chart the best things of their kind.

So our engineers got busy and now they've turned out another item for you—the Color Code Resistor Card.

This is in a convenient pocket size and shows clearly the A, B, C and D color denotations of a resistor. We think it'll fill a definite need on circuit revision jobs.

On the reverse side of the card is Ohm's Law, explained in a way you'll find mighty helpful.

Why not get one of these Color Code Resistor Cards now from your Sylvania jobber? They're free, as are many of the other technical and sales helps listed below. If your jobber is short on any of them, write to Frank Fax, Dept. N-12, Sylvania Electric Products Inc., Emporium, Pa.

#### WARTIME PROMOTION ITEMS

- |  |  |
|--|--|
| 1. Blackout button                         | 5. Air raid precautions folder and window poster |
| 2. First aid index                         |  |
| 3. War bond poster                         |  |
| 4. Radio caretaking hints to the housewife | 6. Direct mail letter                            |

#### REGULAR ITEMS

- |  |  |
|--|--|
| 1. Window displays, dummy tube cartons, timely window streamers, etc. (From your Sylvania jobber only) | 13. Service hints booklets                   |
| 2. Electric clock signs  | 14. Technical manual (35c)                   |
| 3. Electric window signs   | 15. Tube base charts                         |
| 4. Outdoor metal signs   | 16. Price cards                              |
| 5. Window cards  | 17. Sylvania News                            |
| 6. Imprinted match books   | 18. Characteristics sheets                   |
| 7. Imprinted tube stickers   | 19. Interchangeable tube charts              |
| 8. Business cards  | 20. Tube complement books (35c)              |
| 9. Doorknob hangers  | 21. Large and small service carrying kits    |
| 10. Newspaper mats   | 22. Service garments                         |
| 11. Store stationery   | 23. 3-in-1 business forms                    |
| 12. Billheads  | 24. Job record cards (with customer receipt) |

**SYLVANIA**  
ELECTRIC PRODUCTS INC.  
RADIO TUBE DIVISION  
*Formerly Hygrade Sylvania Corporation*

## Spot News

(Continued from page 46)

Japanese-English dictionary of military terms, published by the University of Chicago press. The dictionary is a new edition of a 1932 work originally published in Tokio, and is designed for use by American service men. The authors of the dictionary are Major H. T. Cresswell of the United States Army and Major J. Hiracka and R. Namba of the Japanese Army! Incidentally, Major Cresswell is reported to be a prisoner of war in Japan.

Among the Japanese words and phrases that appear in the book are . . . morusu fugo, which means morse code . . . bekuraito, which means bakelite . . . kyogo no koho, which means a false official statement . . . zempai, which means total defeat . . . shishosha, which means dead or wounded . . . sensei no ri wo ushinau, which means to lose the initiative. And incidentally when you hear the Japs say . . . hakki . . . you will know that they offering the white flag of truce. What an interesting word that will be to millions of American ears!

**FEW WORDS ARE AS APPLICABLE TO OUR** activities, particularly in radio design and development, as the word logistics, the pet word of the military. There are three branches of military science of which this is the last. The first is strategy, which is the planning of warfare. Tactics is the second, and calls for the execution of those plans. Logistics, the third member, is the supplying of everything of necessity to strategy and tactics, in the right amount, at the right place, and at the right time. In total war, how important it is that we apply the science of logistics to all of our activities as a nation, civilian as well as military.

**A NEW PREFERRED LIST OF TUBES** for use in Army-Navy radio apparatus has just been issued. The listing is divided into two sections for receiving and transmitting types, and includes diodes, triodes, pentodes, rectifiers, converters, power tubes in the receiving class and triodes, tetrodes, rectifiers, voltages regulators and phototubes in the transmitting and miscellaneous classification.

The receiving tubes included are: 1A3, 1LH4, 1G4GT, 957, 958A, 1291, 3A5, 1T4, 1S5, 959, 1LN5, 1L4, 1LC6, 1R5, 3A4, 1299, 3Q4, 3Q4, 3Q5GT, 991, 5U4G, 5Y3-GT, 6H6, 9004, 6SQ7, 6SR7, 6J5, 1201, 955, 7193, 9002, 6SL7GT, 6SN7GT, 6SG7, 6SK7, 956, 9003, 6AC7, 6AG7, 6SH7, 6SJ7, 717-A, 954, 9001, 6X5-GT, 1005, 6SA7, 6L6-G, 6V6-GT, 6N7-GT, 6B4-G, 6G6-G, 6Y6-G, 6E5, 12H6, 12SQ7, 12SR7, 12J5-GT, 12S17-GT, 12SN7-GT, 12SG7, 12SK7, 12SH7, 12SJ7, 12SA7, 12A6 and 1629. The transmitting tubes included are: 801-A, 811, 826, 833-A, 838, 1626, 8005,

8025, 304TH, 807, 813, 814, 1625, 803, 837, 2E22, 815, 829, 832, 2X2, 836, 1616, 8020 (451), 705A, 371A, 83, 866A, 872A and 4B25. Miscellaneous tubes include: 2050, 884, 394-A, C1B, C5B, VR-90-30, VR-105-30 (38205), VR-150-30 (38250), 918 and 927. Where interchangeability is assured, GT counterparts of the preferred metal tubes may be used.

These tubes are to be used in all equipment that is basically new, with no similar prototypes. Where of course the equipment involves redesign or basically new ideas, and such equipment is to be manufactured in extremely small quantities, such as for laboratory work, this list does not necessarily apply. The purpose of this list is to effect an eventual reduction in the variety of tubes used in Service equipment, and is in no way intended to hamper or restrict development work in vacuum tubes, or their application.

**A NEW APPROACH** to an old idea has been conceived by some of the department stores in New York City. They are advertising . . . gift barracks, with an added feature, sound. Or your voice in wax, as they explain. Write your letters to the boys in camp with a message on a disc, the stores suggest. We hope it works. We say, we hope, for with the Government cutting down on available shipping space, instituting the V mail form of letter writing and even eliminating records from our boys overseas, we wonder. But notwithstanding, we still say it's a good idea, and we hope the Government will give the plan a complete green light!

**THE SCARCITY OF METAL HASN'T** worried some manufacturers. One, for instance, a metal screw post maker, has developed a plastic screw post. Under test, it proved as serviceable as the metal predecessors, with threads holding up extremely well. Necessity is certainly the mother of invention!

**IT MAY NOT BE LONG** before we have silk again for wire coverings and in a variety of colors. No, we are not



A 155 mm. shell being measured to .0001" by an Electrolimit gauge.

POPULAR PHOTOGRAPHY Special SALON ISSUE

POPULAR  
Photography

OVER 100 PAGES OF BRILLIANT  
SALON PHOTOGRAPHS—Featuring:



**ARMY OVERSEAS PICTURES!  
NAVAL COMBAT PICTURES!  
PRIZE-WINNING PICTURES!**

*Finest of Thousands of Pictures Reproduced in  
Beautiful Blue-Black Gravure and Full Color!*

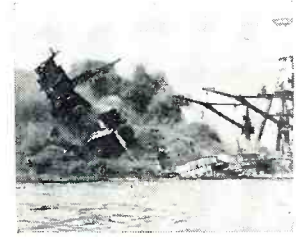

The Special December Salon Issue of POPULAR PHOTOGRAPHY . . . bigger, better and more enthralling than ever before! A super 228 pictorial volume featuring: Portfolio of the finest photographs showing our troops overseas . . . Portfolio of the best Naval combat pictures taken since our entry into the war . . . Portfolio of the choicest prize-winning pictures . . . Special insert of top prize-winning pictures in natural color . . . PLUS—Special Portfolios! Special Inserts! Special Features! Special Articles! . . . All in the biggest, most magnificent December Salon Issue ever published! Get your volume at your favorite newsstand today, or tomorrow sure!



*Special 228-PAGE December*

**SALON ISSUE**

POPULAR  
Photography

NOW ON SALE AT ALL NEWSSTANDS—50c PER VOLUME

# STANCOR

## Professional Series Plate Transformers

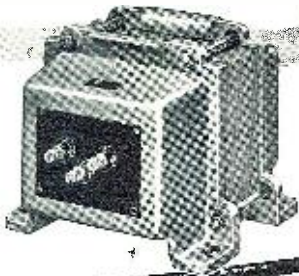

**BUILT LIKE A BATTLESHIP!**

STANCOR'S new Plate Transformers are built like battleships. New housings, new lamination sizes, new balanced coil construction, complete coil potting and new overall methods of manufacture, make these the finest plate transformers obtainable.

### NEW! STANCOR'S PROFESSIONAL SERIES CATALOG

Illustrated in colors, giving complete electrical and physical characteristics of a line of high quality transformers. A copy sent upon request.



**STANDARD TRANSFORMER**

• CORPORATION •  
1500 N. HALSTED ST. CHICAGO

day-dreaming. We are talking about the development of a super-silkworm that has been developed by Dr. Vartan K. Osgian, following sixteen years of research and experimenting in Panama and Venezuela. He has developed trees that have leaves from nineteen and a half to twenty-two inches square, which is six times as large as the mulberry leaves normally used for silkworms. These trees, of which there are now two and a half million are scattered throughout Venezuela at different heights with different temperature conditions. In Venezuela, Dr. Osgian says he can produce eight to twelve silkworm cocoon crops a year, as against a maximum of three anywhere else, including China or Japan. His method of obtaining various colors is the result of special worm gland treatment. Dr. Osgian claims that his silkworms can spin such colors as royal purple, gendarme blue, old rose, jade, jet black, yellow, blue, red, etc.

At present, Dr. Osgian can produce 1,700 pounds of silk a month at his farms. With encouragement he says he can produce close to five million pounds this year . . . enough for a million parachutes and some left over for insulation coverings too.

Dr. Osgian is no newcomer to the silk producing industry. In 1920 he had a silk farm in New Orleans, where he developed silk worms that spun three times as much silk as any other. In the *Department of Commerce* report, of that period, this development was called . . . "the most important in 4000 years." For some reason or other he left the country in 1926 and returned to his native land.

A simple chart has been prepared by Dr. Osgian, showing how every one can produce silk in their backyards. The Venezuelan state of Trujillo has adopted the plan for 160 of its rural schools. Each school is planting 100 more Osgians, as the trees are known, and they expect to have four crops next year. The system, says Dr. Osgian is foolproof, for the trees will grow in any climate; the worms kept indoors, any place. So, maybe we will have silk here after all!

IF YOU ARE INTERESTED IN learning of ways to prolong transmission tube life, we suggest you get a copy of the *Heintz and Kaufman* booklet, recently published. Thirteen ways to prolong life are explained. For instance, they show that in class B audio amplifiers, the "no-signal" plate current can often be reduced without resulting in harmful distortion. Such a reduction saves precious "watt-hours". Another interesting point brought out concerns the grid current of a triode, that is a good indicator of the amount of r-f grid-driving voltage required. In ordinary class C r-f amplifiers, the booklet says, the grid current should be roughly 1/4 to 1/6 the direct current plate current for the tube. For doubler or tripler service, where large grid leaks on the order of 50,000 ohms are employed, the ratio of grid to plate current may fall

off to nearer 1/10. A good experimental way to adjust to the proper amount of grid drive, is to reduce the drive until the efficiency of the tube starts to fall off. This will be indicated by a visible increase in plate heating. The grid drive should then be restored somewhat above this fall-off point.

The booklet is free. The address is South Francisco, California.

### Personals . . .

Joseph L. Graf, Sr., engineer of telegraph and telephone of the Delaware, Lackawanna and Western Railroad, and famous for his pioneer train-radio experiments, retired recently. In 1913, Mr. Graf, began experimenting with radio communication on fast moving trains. In collaboration with Colonel David Sarnoff, president of RCA, Dr. Lee De Forest, Charles Logwood and many others, he conducted the first successful radio train communication demonstration . . . Carl J. Myers, chief engineer of WGN, Chicago's popular station, has been commissioned a lieutenant commander in the Navy and will be temporarily stationed in Washington on a special radio assignment. George Laug, chief transmitter engineer, has succeeded Mr. Myers . . . Henry A. Hutchins, the general sales manager of National Union, has also joined the Navy as a lieutenant commander . . . Dr. Edward C. Elliott, president of Purdue University and chief of the Manpower Commission's technical and professional training division, is now serving as the chairman of a committee to formulate a coordinated plan for meeting the needs of the Army, Navy and war industries, for a continued supply of engineers and other scientific personnel. . . One of the most capable executives in Washington is Leighton Hartwell Peebles, chief of the Communications Branch of the WPB. Having supervised the engineering and construction of the American group of eight transoceanic radio stations for American Marconi in Massachusetts, New Jersey, California, and Hawaii in 1912, and having served in a variety of other engineering developments of equal importance over the span of intervening years, it is no wonder that he is so fully equipped to solve the hundreds of intricate and puzzling problems that cross his desk every day. Here's one man in Washington who is doing his job . . . in a way that merits applause! . . . Mefford R. Runyon, vice-president has been commissioned a lieutenant commander in the Naval Reserve. He will probably be assigned to work in Naval Communications after taking an indoctrination course at the Noroton Naval Radio Training School . . . Quite a few more radio companies have joined the ranks of "E" pennant winners. They include Westinghouse, Ward Leonard, Stewart-Warner and Eitel-McCullough. In celebration of winning this Army-Navy award, IRC sent out an "E" display card to all of its distributors.

-30-

**Mrs. Literature**  
(Continued from page 37)

other subjects. Copies can be obtained from *Heintz and Kaufman, Ltd.*, 1020 Tanforan Avenue, South San Francisco, California.

**Precision Bulletin No. 202**

*Precision Tube Co.*, of Philadelphia with Sales Office at 2957—214th Street, Bayside, Long Island, N. Y., have announced the issuance of their new Bulletin No. 202 covering Precision Metal Shielded Wire by their method of protecting insulated wires enclosed in either thin wall seamless aluminum, copper or lead tubing—"The positive answer to perfect shielding and maximum Mechanical protection."

**How to Make Your Transmitting Tubes Last Longer**

This booklet released recently by the Radio, Television and Electronics Departments of the *General Electric Company*, Schenectady, N. Y., tells how to make radio transmitting tubes last longer. Included are complete analyses on pure tungsten filament tubes, mercury vapor tubes and thoriated tungsten tubes. The booklet is available on request to the above address.

**Electrolytic Capacitors**

Catalog 12-Section A was released by the *Solar Manufacturing Corp.*, Bayonne, N. J. This new catalog consists of 32 pages profusely illustrated with data arranged especially for the design engineer. Section A may be had by request providing a letterhead is used.

In addition to the items shown in this booklet, many other electrolytic types are produced by the Solar organization who manufacture blueprint specifications.

**Incco Bulletin Released**

Incco Bulletin 1031 has just been released by the *Industrial Condenser Corp.*, 1725 W. North Avenue, Chicago, Ill. Included are many commercial and military types of electrical capacitors. The needs for new and improved products brought about by war conditions and alternates for material have made it necessary to redesign or to design new equipment to meet the rigid specifications. Copies may be obtained from the Industrial Condenser Corp. by request on letterhead.

-50-

**WINNERS**  
in the  
**National Inventors**  
**Contest**  
will be announced  
**NEXT MONTH**

December, 1942

**AS TOUGH AS THE MEN  
WHO USE THEM!**



**O**UR FIGHTERS are tough! They must be when, midst the rhythmic whine of bullets... the strident din of roaring cannon, they are face-to-face with a treacherous, ruthless enemy. Their rigorous training must provide them with superior fighting qualities. As in men so in Microphones. They, too, must be tough to match the rugged fighter. Microphones made by Shure Brothers *are Tough* because they have survived tests in engineering and production more destructive than conditions they meet in service. Truly a fighting pair serving the cause of Freedom... the fighter and his "Fighting Mike".

**SHURE BROTHERS**  
*Designers and Manufacturers of Microphones  
and Acoustic Devices*  
225 West Huron Street, Chicago

**SHURE**

**FIGHTING MICROPHONES**

53

# Today POLYMET is a WAR INDUSTRY

For **VICTORY** Buy  
UNITED STATES SAVINGS BONDS  
AND STAMPS

Much of our production goes to contractors directly engaged in communication installations for the army and navy. At the same time, we are making every effort to serve the growing civilian demand for POLYMET.

Condenser replacements account for about 40% of all radio repair jobs. Dependable condensers are, therefore, essential for gaining and maintaining maximum customer satisfaction.



PROTECT **40%**  
that

NOW, more than ever, the jobber and service man must recognize the growing demand for POLYMET.

## CONTINUOUS DEPENDABLE SERVICE

For 21 years POLYMET ELECTROLYTIC and BY-PASS CONDENSERS have improved quality and service. New researches under the necessity of war requirements are placing POLYMET even further ahead in its field. We're conserving vital materials by limiting sizes to those most universally used. These serve practically every need.

Complete listing of available types and prices will be forwarded upon request.



**POLYMET  
CONDENSER CO.**

699 EAST 135th ST.,  
NEW YORK N. Y.

## Electronic Detectives

(Continued from page 40)

an electronic device as a further contribution in minimizing the destruction of ocean cargoes by way of Davy Jones' locker.

Axis submarines, preying upon Allied shipping, spot smoke from a vessel's smokestack as a telltale of ocean-plying ships. The ship's fireman, mindful of the possible revealing sign of smoke, tries to avoid incomplete combustion of coal, but not infrequently clouds of soot stream aloft. Engineers, taking their cue from the practical application of the photoelectric tube in factories and other industrial plants to spot the telltale of soot issuing from smokestacks, have recommended the installation of "electric eyes" or phototubes in the smokestacks of ships. Then, the fireman would be instantly warned when smoke began emanating from the firebox. A beam of light is thrown across the smoke column in the smokestack and compelled to shine on the photoelectric tube. When the soot becomes excessively thick, the light of this "electric eye" is blocked and the electronic device actuates a relay—forthwith an ominous warning is sounded to the fireman. This "flash" enables the latter to apply corrective measures—clearing the sooty conditions, as well as conserving fuel.

The so-called "Peeping Tom" electron tube is detailed to perform a delicate job in the refining process of precious metals. The crude, crushed ore is washed in "liquor," so described by mining engineers. Not unlike the human body, if this "liquor" becomes too acid or too alkaline, it deteriorates in quality—and in being deprived of some of its effectiveness, a portion of the valuable metal escapes. A proper balance between excessive acid and too much alkaline in the "liquor" may be maintained by the addition of lime water. But this tedious, time-consum-

ing process of drawing off a specimen of the "liquor," testing it in the laboratory, and then measuring the required lime water—well, the undertaking taxes the patience of a Job. So, here is where an electronic device becomes a "Peeping Tom"—a photoelectric tube has the "license" to be located in one of the refining pipes, "look" through a glass window, and as the color of the liquid begins to change, the correct amount of lime water is added, automatically.

Initially, about 21 per cent of the draftees of the Selective Service Act were rejected outright, or given deferred classification by reason of faulty teeth. The X-ray machine includes the all-seeing eye of electronics—and the flippant phrase "by the skin of their teeth" no longer applies to soldiers on the fighting fronts because the electron tube "looks" at the insides of a tooth, a person, or a gun-mount. The dental X-ray is one of the offspring of the science of electronics, and in current dental practice, no tooth is pulled and no bridge located in a soldier's mouth without first using the penetrating "eye" of the X-ray machine. As a result, bad teeth receive immediate corrective measures in American armed forces.

Figuratively, the science of electronics is measuring the diameter of a bubble—although the latter vanishes the moment one touches it. Actually, that wonder-working electron tube is determining the thickness of layers of metal foil to the fineness of one one-hundred-thousandth of an inch—comparable to the precision of a balance in weighing a signature. These layers of foil similar to foil around a candy bar, are so fragile and sensitive that conventional measuring instruments are too rough to touch them—they would disappear like a bubble of soap. With the advent of the electronic gage, this metal foil is rolled out, passed between two metal discs, and without the foil being contacted, its exact thickness is measured. This means that *Pratt & Whitney*, famed manu-

Front panel of a G-E photoelectric Pyrometer and phototube holder.

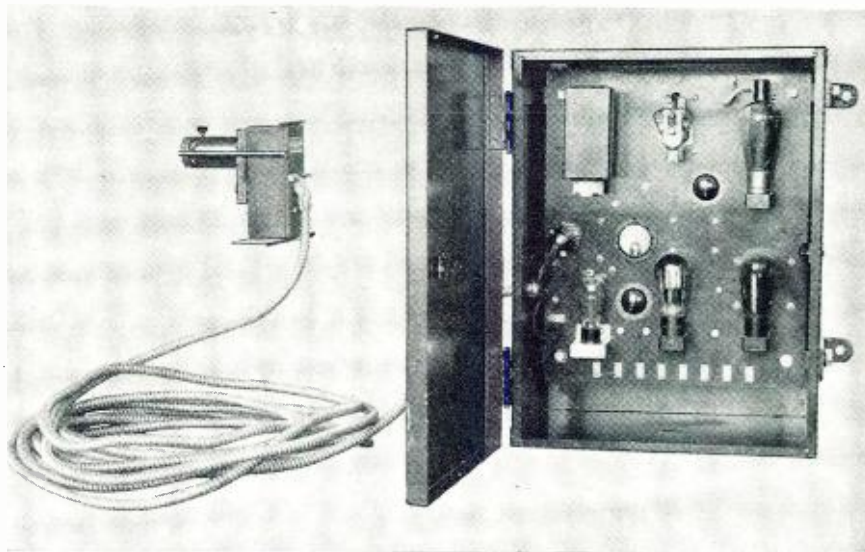

# PRACTICAL HOME-STUDY RADIO COURSE

These men used this course to get into good radio jobs



### FINEST TRAINING COURSE USED IN SCHOOLS

"The radio training course is the finest up to date easy to understand course. . . . This course outlines practical work. We are using this course in our Topeka High School. It is wonderful." Henry Ward, Jr., 622 Filmore St., Topeka, Kansas.



### WORTH MUCH MORE

"You should get more money for the R.T.I. Course. The first week I studied it, I made \$10.00 repairing sets. I built my own test outfit from details given in this course. I have repaired 100 radios to date. . . ." Robert C. Hammel, 709 E. 10th St., Davenport, Iowa.



### COMPLETED IN 8 WEEKS

"I am very satisfied with the course. When I was at the twelfth lesson I started repairing radios. It took me two months to master your course." Roger Lanzlois, 1720 Poupart, Montreal, Canada.



### MODERN UP TO DATE

"I have found since taking your course how modern and up to date it really is. There is not one page in the whole course which anyone interested in radio can afford to miss. Your course started me on the road to a well paid job and has helped me many times." Charles Alsbach, 433 Elm St., Reading, Pa.

## AMAZING BARGAIN OFFER

Here is your chance to get practical training in radio almost free. In this single large course-manual you have the material covered by the best \$100.00 radio correspondence course. All the lessons are included in this course-manual and cover every phase of modern radio work. Men with radio training are urgently needed in defense plants, service shops, Civil Service jobs, and in the Army and Navy. Let this low priced course-book prepare you for a better job in radio or higher pay in the Armed Forces.

### PRACTICAL TRAINING

These simplified, well illustrated lessons are interesting, easy to understand and apply. The first lessons explain to you the important radio principles and methods. The later lessons in the course-manual teach you advanced servicing practice. No special previous knowledge is needed. Everything you need is included in this one large course-manual. You will find the material timely, up-to-the-minute, and of great help on the job.

### LATEST DATA FOR RADIOMEN

Learn new speed-tricks of radio fault finding, case histories of common trouble, servicing short-cuts, extra profit ideas. Included are many large lessons on the use of regular test equipment, explanation of signal tracing, television to the minute, recording dope. With this information you will save enough time on a single radio job to pay the special \$2.50 price for the complete course of 22 money-making lessons. Many active servicemen used this reduced price radio training for brush-up and study of new servicing methods.

### Money-Back Guarantee

You must be entirely satisfied or your money will be refunded without a question. You are permitted to make full use of the course for 10 days on a trial basis.

### IN BOOK FORM

**\$2.50**  
COMPLETE

**SPECIAL OFFER**  
**READ THE DETAILS**

### EVERYTHING IN RADIO

Every new development of radio is included in this complete course-manual. There are lessons on servicing instruments, signal tracing, transmitters, television, P.A., photo-cells, etc. Practical suggestions, service hints, repair methods. Thousands of important, time-saving radio facts are packed into this complete course-manual available today for only \$2.50, postpaid.

### EASY TO UNDERSTAND

The practical lessons making up this course-book are easy to follow and apply to actual radio jobs. Hundreds of radio facts that puzzled you will be quickly cleared up. You will find yourself doing radio repairs in minutes instead of hours—quickly finding the faults or making needed adjustments. Get into radio for more important war work and better pay. The Armed Forces also need radio men and give higher rank and better pay. If you are already in Radio, improve your knowledge with this low-priced radio course.

### 10 DAYS' EXAMINATION

All the lessons of the original course have been reprinted in a single large manual. The very newest data on auto sets, signal tracers, new tubes, etc., are included. You get a complete course of training at the unheard of price of only \$2.50, nothing else to pay. And further, you risk absolutely nothing. You try the course for 10 days. If you are satisfied, the total price for the complete course is only \$2.50. If you are not pleased, you receive a complete refund.

### SELF-TESTING QUESTIONS

The course-manual is supplied complete with all lessons, tube data and supplementary material. Questions at the end of each lesson are used for self-testing and review. Order the course-manual on a 10 days' trial basis. You risk nothing. Don't pass up this remarkable offer.

### LIMITED QUANTITY ON HAND

There are only 740 copies of this 5th Edition on hand. We do not know if another edition will be permitted. Rush coupon for your course. Remember that the 10 days' examination period eliminates all risks on your part.

These lessons will tell you all about

- Induction, Coils
- I. F. Transformers
- Alignment
- Condenser testing
- Batteries
- Filters, Rectifiers
- Reactance
- Auto antennas
- Beam power tubes
- Superhets, TRF
- A.V.C. circuits
- Ballast tubes
- Oscilloscopes
- V.T. Voltmeters
- Loud speakers
- Vibrators
- P. A. testing
- Recording
- Service hints
- And thousands of other radio topics.

## Other Practical Radio Manuals



### SIMPLIFIED RADIO SERVICING

Revolutionary different COMPARISON technique permits you to do expert work on all radio sets. Gives practical pointers and suggestions. Covers every radio set—new and old models. In handy manual form, size 8 x 11 inches, 112 pages. Over 1,000 practical service hints, 16 large, trouble-shooting blue-prints. . . . . **\$1.50**



### MOST-OFTEN-NEEDED RADIO DIAGRAMS

The most popular radio diagrams available in low priced manuals. Large size; 8½ x 11 inches. 1942 Manual, Volume 5, 204 pages. . . . } **\$2.00**  
1941 Manual, Volume 4, 192 pages. . . . }  
1940 Manual, Volume 3, 208 pages. . . . } each NET  
1939 Manual, Volume 2, 192 pages. . . . } **\$2.50**  
1926-38 Manual, Volume 1, 244 . . . . } pages, alignment, hints, parts lists. . . .



### PRACTICAL RADIO MATHEMATICS

Introduces and explains the use of arithmetic and elementary algebra in connection with units, color code, meter scales, Ohm's Law, alternating currents, ohmmeter testing, wattage rating, series and parallel connections, capacity, inductance, mixed circuits, vacuum tubes, curves, the decibel, etc., etc., and has numerous examples. Net. . . . . **25c**

SEE YOUR RADIO JOBBER OR SEND COUPON

# Supreme Publications

PUBLISHERS OF RADIO BOOKS, MANUALS, AND DIAGRAMS

328 South Jefferson Street

Chicago, Illinois

## "NO RISK" TRIAL ORDER COUPON

SUPREME PUBLICATIONS, 328 S. Jefferson St., Chicago, Ill.

Ship my copy of the complete Radio Course-Manual, including supplementary data and review questions. I must be entirely satisfied or you will refund my total remittance in full.

- I am enclosing \$2.50, full price. Send postpaid.
- Send C.O.D. I will pay the mailman \$2.50 and a few cents postage.
- Also send other Supreme Publications books as listed on attached paper.

NAME .....

ADDRESS .....

# OHMITE

Rheostats • Resistors  
Chokes • Tap Switches

## HELP YOUR WAR EFFORT

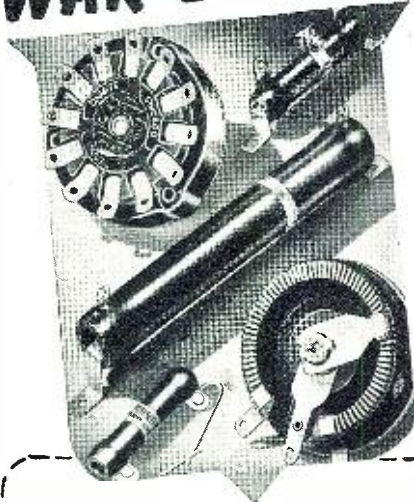

**ON THE WAR FRONT**—Many of you now in active service have long been familiar with the dependability of Ohmite Products. When you notice so many of these same units in vital war equipment on land, at sea and in the air, it gives you added assurance and helps you fight a better fight.

**ON THE HOME FRONT**—Here, too, you find innumerable Ohmite Resistance Units in radio, communications and electronic devices, in test apparatus and electrical control equipment. This knowledge helps you do a better job in dealing with today's resistance-control problems or in maintaining the service of existing equipment.



**Send for These Handy Aids**

**Ohmite Ohm's Law Calculator**  
Helps you figure ohms, watts, volts, amperes—quickly, easily. All values are direct reading. No slide rule knowledge necessary. 4½ x 9". Send only 10c in coin to cover handling cost.



**Quick-Reference Catalog 18**  
Gives up-to-date information on the wide range of Ohmite Stock resistors, rheostats, chokes and switches used in all types of applications. Write for it now—it's free! Ohmite Jobbers Everywhere.

**OHMITE MANUFACTURING COMPANY**  
4385 Flournoy St., Chicago, U.S.A.

**Be Right with OHMITE**  
RHEOSTATS • RESISTORS • TAP SWITCHES

facturers of aviation engines, can equip fighter planes and bombers with many electronic devices at economic savings.

Electronic detectives may operate under the guise of smokestack spies—acting as a metallic watchman for any telltale of soot from a chimney that may spoil a housewife's wash-day, soil window curtains, and even contaminate food. The "electric eye" poses as a magic watchman, on a 24-hour day, informing any fireman of an excessively smoking chimney. This "electric eye," almost human-like, watches a beam of light as it is hurled across a column of smoke in the chimney. When the smoke thickens excessively, the beam of light is blocked out and at the same time, a bell rings as a warning signal. When the smoke clears, the bell ceases ringing.

Linemen, climbing poles as they jab their spurs at precarious points in ascending, may find an ally in searching for faulty electric-power lines during practice blackouts and other wartime exigencies. War industries, cities and homes may be doomed temporarily to blackness by army decrees, but failure of an electric power cable cannot be tolerated for long. To avoid blackouts by default, electronic devices are employed to locate faults in power cables—a line detective, as it were—and indicate to the power line patrolman the exact spot of the trouble. *General Electric* engineers have designed a mechanical sleuth in the form of a series of master electronic tubes, and this instrument ordinarily locates a cable-fault within one hour. If, however, the weakness is difficult to find, this multiple-arrangement of electron tubes forces an electric current through the cable suspected of harboring trouble, which procedure makes trouble-shooting definitely fruitful.

An invention of such amazing implications as to tax our credulity is the electronic device for testing the ripeness of fruit. Designed and patented by Howard L. Clark of Ballston

G-E electronic smoke indicator.

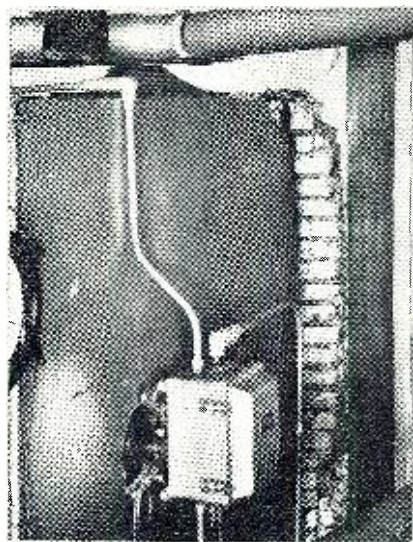

Lake, New York, and Walter Mikelson of Schenectady, New York (patent rights assigned to the *General Electric Company*), this instrument functions in accordance with the principle that green fruit transmits vibrations more readily than ripe fruit. And, we are told, this characteristic is measurable in determining the ripeness, for example, of a pineapple.

The electron tubes are used in a suitable radio circuit with a feed-back oscillator for transmitting the vibrations of a pineapple or melon. The two essential units of the apparatus are a vibration radio transmitter and a vibration pick-up device. A phase shifter is included somewhere in the current as a means of quickly obtaining a phase relationship favorably to radio regenerative action, just as some of those early regenerative radio receivers were miniature broadcasting stations. In the fruit-ripeness tester, the generated vibrations are picked up, converted into current pulsations, amplified, and then reconverted into mechanical vibrations. The natural period of vibration, according to tests, decreases with the degree of ripeness of the sample of fruit. Odd looking is the location in this electronic circuit of a pineapple instead of the usual radio unit. Now, by virtue of this novel invention, the grocer or housewife may consult a radio or electronic outfit to determine the ripeness of fruit—instead of the former procedure of squeezing a fine apple or thumping a watermelon.

—30—

### Electric Eye

(Continued from page 9)

these devices, the tubes are used similarly to those in the motion picture instruments, with photographed or engraved modulations causing a variation in the input by way of a light source and phototube and a consequent sound variation by way of an amplifier, in the output.

There are two specific types of phototubes used in some forms of photoelectric work. One is a high vacuum phototube possessing extraordinarily high sensitivity to radiant energy rich in blue and near ultraviolet and responding in the region down to about 2,000 angstrom units. This tube, typified by the recently announced RCA 935, employs a bulb of special glass featuring a high transmission factor for ultraviolet radiation and top-cap construction to provide high resistance to leakage currents between electrodes.

Both the vacuum tube and the cell type units have, as we have seen, distinctive functions to perform in electronics today. And effectively adopted, these unusual products of science, offer advancements far beyond the imagination of anyone. They are truly a vital factor in these days of scientific marvels.

—30—



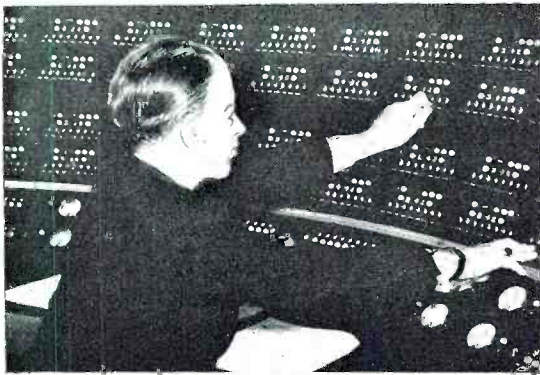

**MASTER ALL BRANCHES OF RADIO**

NOW, as never before, the urgent need for Trained Radio Men has created a tremendous shortage. Man-power is being mobilized for duty on the TECHNICAL FRONT: Radio Engineers, Service men and operators, Experts in shops, in laboratories and countless, undreamed-of other applications are on the "MUST HAVE" list. The war has stimulated demand in both Civilian and military fields. Regardless of whether you remain a civilian or enter Military Service, National Radio Training will qualify you for a real future, a good pay job, responsibility and marvelous opportunity for advancement.

**LEARN AT HOME**

Now you can learn AT HOME in your spare time. National's VICTORY training plan speeds up your progress right from the start, yet omits absolutely nothing vital to your preparation.

**FASCINATING WAY TO LEARN RADIO**

Eliminating dry text books, National's plan of rapid Home Training actually brings you the proved Shop-Studio-Field service methods that are followed in National's resident training shops. This training is simplified so that you can easily grasp Radio step by step in a way that grows in its fascination every day. No previous experience needed. When you complete this Course you are prepared for a good radio job at excellent pay or may establish your own radio business. Bear in mind that with the war-time curtailment of radio sets there is a huge increase in service work in homes. Radio manufacturing plants also need trained technicians to help produce over two billion dollars worth of military radio equipment. Factories are installing elaborate sound systems. Electronics is growing by leaps and bounds. Defense radio installations are without limit. All sound systems and innumerable defense hook-ups require Trained men. Prepare yourself for these job opportunities. Enroll and Train by National's easy-to-grasp home method.

**National Graduates Win Good Jobs**

**Radio Lab. Specialist**  
"I got a job with International Telephone & Radio Co. Am working in their laboratory developing new Radio equipment, ultra-high frequency receivers and transmitters. It's a good, straight salary job."

Douglas Nielsen,  
Jamaica, N. Y.

**U. S. CIVIL SERVICE**

"Am now employed by Civil Service as Junior Aircraft Radio-Electrician at McClelland Field. There are several other National Schools graduates employed by this Dept."

Milton H. Ross,  
No. Sacramento, Calif.

**National Training Helps**

"Promoted to Instructor in Circuit Analysis at U. S. Army Air Corps here at Scott Field. Your Course has helped me very much and am sure it is responsible for my success."  
Leland Gillum,  
Scott Field, Illinois.

**MEN WANTED:**  
Ages—16 to 50  
In Radio, age is not a factor. Training is the main requirement.

More than 37,000 Graduates

**USE THIS COUPON**

**BE A RADIO TECHNICIAN WITH PREPARATION FOR CIVILIAN OR U.S. GOV SERVICE**

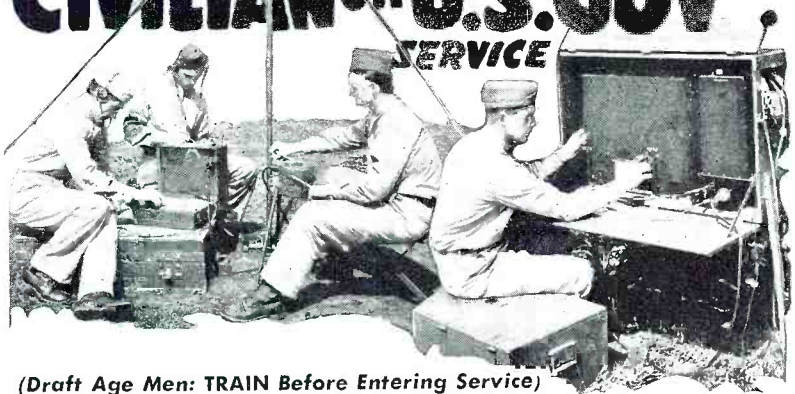

(Draft Age Men: TRAIN Before Entering Service)

**TESTED HOME TRAINING BY PROVED SHOP-FIELD METHOD**

For 37 years National Schools has trained ambitious men for Top Pay trades. Squarely behind your Home Training are the modern, completely-equipped Training Shops of National Schools where we develop and prove every Shop Method Assignment sent to you. Every phase of your training is personally supervised by an established Faculty of practical, experienced instructors and engineers. They have developed progressive methods of training you in your own home, based on actual shop practice. Unique training facilities give you Home Training based on Resident School Shop principles—methods not available from any other source, to our knowledge. You'll be amazed when you receive our Complimentary Lesson and full details.

**KEEP PRESENT JOB WHILE LEARNING**

Regardless of previous education or age, you can Train for Radio. Continue your present job. Earn while you learn. If subject to Military Service, all the more important that you get pre-training.

**MILITARY SERVICE**

Prepare for Radio Service in Army and Navy. In U. S. Gov't. service you install, operate and maintain most technical equipment such as secret ultra-high frequency apparatus to locate airplanes. Get promotion in rank and increased pay almost from the start.

**SPECIAL OFFER**

So that you can demonstrate to yourself the ease and rapidity of learning Radio at home, National Schools will present to you one Complimentary Lesson free, accompanied by Opportunity Book of Facts and Details about all branches of Radio. Use the Coupon. Mail it today!

**NATIONAL SCHOOLS**

**HOME TRAINING HEADQUARTERS**

**Los Angeles**

**California**

ESTABLISHED 1905

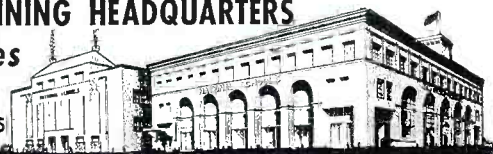

**MAIL OPPORTUNITY COUPON FOR QUICK ACTION**

National Schools, Dept. 12-RN (Mail in envelope or 4000 So. Figueroa, Los Angeles, Calif. paste on penny postal)

Mail me FREE, without obligation, one Lesson and Opportunity Book, with full details about how I CAN become a RADIO Technician.

NAME \_\_\_\_\_ AGE \_\_\_\_\_

ADDRESS \_\_\_\_\_

CITY \_\_\_\_\_ STATE \_\_\_\_\_



## YOUR OPPORTUNITY IS NOW!



## Get the Better Radio Job You Want—

**CREI Technical Training Enables You To Go After — and Get The Better-Paying Jobs That Will Always Mean Something In Radio**

● Face the facts! Present-day conditions which surround employment and promotion in all branches of both civilian and military radio are actually unbelievable. The tremendously expanded demand for technically trained radiomen has created a condition wherein there are many more jobs than qualified men to fill them.

● Hundreds of men have had new jobs at comparatively high pay literally thrust upon them. Manufacturers are offering increased base pay to attract new additions to their staffs. The Civil Service Commission has revised its standards in many of its examinations, and the Army, Navy and Marine Corps are offering to properly qualified technically trained radiomen ratings as high as staff sergeant and chief radioman as an inducement to enlist. All of this means that Opportunity . . . is here, now!

● If you have a commonplace job—a temporary job. If you are a "ham" who would like to make your avocation your vocation—if you have the ambition to hold a position of greater responsibility with higher pay . . . then enrolling for, and completing a CREI home study course in Practical Radio Engineering is the most important thing you can do toward accomplishing your ambition at this most opportune time.

### ● WRITE FOR FREE 32-PAGE BOOKLET

If you have had professional or amateur radio experience and want to make more money—let us prove to you we have something you need to qualify for a better radio job. To help us intelligently answer your inquiry—please state briefly your background of experience, education and present position.



### CREI Students and Graduates — ATTENTION!

The CREI Placement Bureau is flooded with requests for CREI trained radiomen. Employers in all branches of radio want trained men. Your government wants every man to perform his job, or be placed in a job, that will allow him to work at maximum productivity. If you are or will be in need of re-employment write your CREI Placement Bureau at once.

## CAPITOL RADIO ENGINEERING INSTITUTE

E. H. RIETZKE, President

Home Study Courses in Practical Radio Engineering for Professional Self-Improvement

Dept. RN-12, 3224 — 16th Street, N. W.  
WASHINGTON, D. C.

Contractors to the U. S. Signal Corps—U. S. Coast Guard  
Producers of Well-Trained Technical Radiomen for Industry

## Civilian Training

(Continued from page 13)

bustion and ignition systems and an introduction to the vacuum tube. At the same time he receives shop work which is correlated with his classes and lectures.

Upon graduation to the junior radio repairman trainee course, he continues with his studies of the vacuum tube. At the same time he is introduced to Receiver circuits and their measurement which includes the superheterodyne, AVC, AFC, television and FM receivers and also trouble shooting in these circuits. Together with this, complete courses are given in transmitters through ultra high frequencies including FM and studies of antennae and transmission lines. Through the three month period as a junior radio repairman trainee his laboratory work is again correlated with the lecture room. Both actual construction of receivers and transmitters are necessary for the successful completion of this course.

Since both mechanic learners and junior radio repairman trainees are hired from lists submitted by the Civil Service Commission, it is necessary for the applicant to file with the Commission. However, in order to qualify for the Mechanic Learner, the applicant must pass a Mechanical Aptitude examination which is given by the Civil Service Commission and upon successfully completing same is placed upon the availability list as issued by the Commission.

Upon orders issued by the Chief Signal Officer, Major General Dawson Olmstead, the Civilian Training Program was recently organized in the nine Service Commands covering the continental United States. Within these Service Commands schools have been organized, equipment purchased and instructors hired to further the program. Men who have had the necessary qualifications or who have successfully passed required examinations of the Civil Service Commission, have been admitted to the various schools and are now actively engaged in their courses of study. These schools are now equipped to handle a large number of students at any one time.

Eligible persons who are in the "1-A" or "1-B" Selective Service Classification must enroll into the Enlisted Reserve Corps, Signal Corps Branch, prior to their admission to any of the courses. In addition these men will be given preference for admittance into the course. Prospective class "1-A" men should join the Enlisted Reserve Corps so that when they are classified by their draft boards, they can remain with the Signal Corps. If this is not done, then the man can be assigned to any branch or arm of the Army without regard to personal desires of the individual.

Upon completion of the course, the Reservist is called into active service

as a private. However, with the specialized training that a man receives in the various schools, he obtains a technical knowledge of Signal Corps equipment and should advance in grade much faster than a man who has not had this specialized training. Furthermore, if a man shows himself to be of officer material, he will have the opportunity of applying for the Officers Candidate School at the completion of his 13 weeks basic training. Upon successful graduation from the Officers Candidate School he will be commissioned as a Second Lieutenant in the Signal Corps of the Army.

Applicants who wish further information about the two courses offered should apply to the Civilian Training Section, Signal Corps, at the Service Command in which they are located. The address of the Service Commands may be obtained from any U. S. Army Recruiting Office.

It is further suggested, that those men who wish to apply for admittance to the school, should go to their nearest post office and ask the postmaster for Civil Service Form No. 4000ABC. Upon filling out this form it should be mailed to the Manager of the U. S. Civil Service District in which the applicant resides. The applicant will then be notified when an examination will be held.

—30—

## Forest Defense

(Continued from page 48)

receiver battery drain is small enough that "stand-by" operation of battery receivers is possible. By using one frequency for transmitting and another for receiving a pair of stations may be operated "duplex"—that is, talk and receive simultaneously.

Ultra-high frequency lends itself admirably to linking up emergency lookouts with the regular *United States Forest Service* lookout system. It has been used successfully also for communication nets on large project fires. Two-way communication with moving vehicles is also possible.

Ultra-high-frequency operation in the *Forest Service* is still comparatively new. Almost every day new tubes, parts, and technique are being developed by the *Service's* radio technicians. In order to take advantage of these new developments the *Forest Service* is continuously making sweeping revisions in its ultra-high-frequency equipment.

Most of the work of development of new equipment, revision of existing models to keep pace with the current state of the art, and improvements in the application and technique of radio communication, is done in the *Forest Service's* own radio laboratory at Portland, Oregon. As they gain knowledge of its possibilities, they find that the variety of uses to which radio can be put in forest protection becomes increasingly greater.

—30—

## Training Radio Ops

(Continued from page 36)

is primarily used for radio communications with aircraft stations, but which may also carry on a limited fixed service with other aeronautical stations in connection with the handling of communications relating to the safety of life and property in the air. Still another form of station is the aeronautical fixed station that is used for the handling of point-to-point communications relating to actual aviation needs. An interesting type of station is the airport control station, which is used to provide communications between airport control tower and aircraft stations in the immediate vicinity of the airport.

The flying school station is a station used for communications pertaining to instructing pilots while in flight. Then we have the instrument landing station that is a special service station used for facilitating the landing of aircraft. This may include the use of a glide path transmitter, localizer transmitter, combination glide path and localizer transmitter or approach marker transmitters. As an aid to air navigation there is the radio marker station. This may be one of several types, such as the fan marker, inner marker, outer marker or Z marker.

It can be seen that the prospective radio operator aboard a plane or on the land must have a thorough transmission and reception schooling in truly a maze of subjects. He or she must even be familiar with ciphers that will permit conversation with an operator who might speak an-

other language. This is similar to the cryptography methods used in commercial and particularly in military circles.

Schooling in airline practice does not only involve a study of code transmission. It also covers an intensive study of the theory, practice, application and maintenance of airline communication equipment. Topics are broken down

for analysis. For instance in the study of vacuum tubes, the tubes studied in many instances are completely peculiar to aircraft equipment only. Thus it is necessary to study them under operating conditions that cannot exist elsewhere. So that this and other subjects may be thus analyzed, an unusual dynamic instrument using the cathode-ray tube was devised by Har-

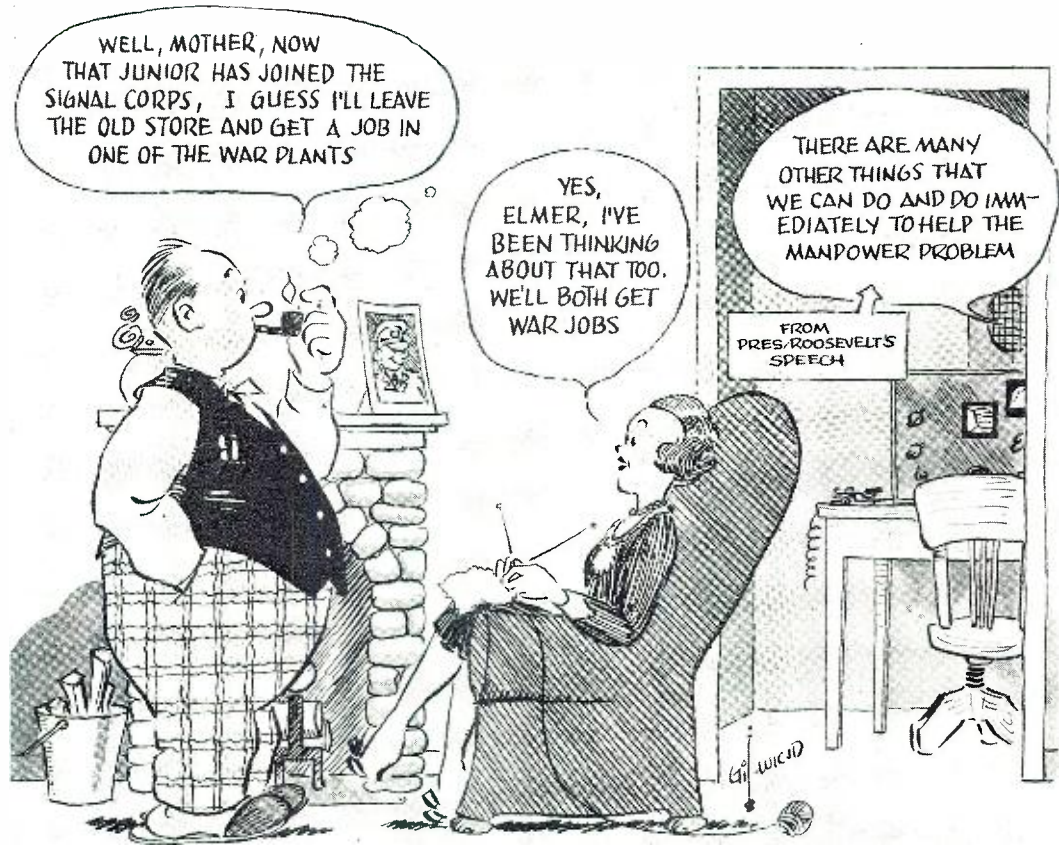

THIS is everyone's War . . . if you are not able to serve in the Army or Navy, you can serve on the production front. Elmer is doing his *duty* by leaving his non-essential position and taking a job in the war plant.



# HAMMARLUND

THE HAMMARLUND MFG. CO., INC., 460 WEST 34TH STREET, NEW YORK, N. Y.

**IT'S ALLIED ALWAYS  
FOR EVERYTHING IN  
RADIO AND  
ELECTRONICS**



Your ALLIED Catalog is the key to Everything in Radio and Electronics — lists Test Equipment, Tools, Tubes, PA Systems—over 15,000 Radio and Electronic Parts for industrial application, for war use, for instruction, for service replacement. And all this is backed by radio's most complete stocks and speediest service! ALLIED SERVES:

**WAR INDUSTRY**



American War Industry counts on ALLIED for its Radio and Electronic equipment used in industrial research and production operations. Priority orders are given special attention; quotations covering all Electronic equipment are promptly furnished.

**ARMED FORCES**



ALLIED is at the service of our Armed forces, supplying thousands of Radio and Electronic items to every branch of the services for active use as well as for instruction purposes. War service has the "green light" first at ALLIED today.

**RADIO TRAINING PROGRAM**



ALLIED specializes in supplying the needs of War Program Radio Training classes. Our Educational Division has helped hundreds of schools plan and carry out their projects. Radio Training instructors are invited to write for valuable information.

**THE HOME FRONT**



ALLIED helps to keep American radios working at top efficiency by cooperating with radio servicemen, supplying service data help and replacement parts in a manner consistent with the requirements of the war effort

**KEEP YOUR ALLIED CATALOG HANDY  
FOR EVERYTHING IN RADIO!**

**ALLIED RADIO CORP.**

833 W. Jackson Blvd., Dept. 1-M-2  
Chicago, Illinois

Send me your FREE 1942 Radio Supply Catalog.

Name.....

Address.....

City..... State.....

vey Pollak, who is the chairman of technical department of the *Melville School*.

Of all the test instruments designed for commercial applications in transmitter and receiver testing, the cathode-ray oscillograph is the most versatile, and is best adapted for classroom demonstration work, according to Mr. Pollak. In the classroom, it makes its first appearance after the study of direct currents has been completed. Since it is a device primarily intended to provide a visual reproduction of sequence and form of changes in alternating potentials, it first may be used to trace the sine curve from the 60 cycle power supply. It is during this demonstration that the students learn the use of the intensity control, the focusing control, the centering potentiometers and the sweep frequency knobs used in conjunction with the amplifier gain controls.

The oscillograph together with an electronic switch makes it possible to view two distinct input voltages as two separate wave-forms separated from each other by as much or as little as the operator desires. It is thus possible to demonstrate in an exceptionally clear manner that the voltage drop across a resistor is out of phase with the drop across a condenser or inductance connected in series with it, by applying the former IR drop across one set of input terminals on the electron switch.

The direct-filter power supply system is studied as a direct application of the diode and as a tie-in between a.c. and vacuum tubes, according to Mr. Pollak. By means of a set of knife switches connected in appropriate positions on the power supply board, the oscillograph may be used to great advantage to show many factors. They are . . . (a)—the half-wave unfiltered . . . (b)—the full-wave unfiltered . . . (c)—the effect of each filter condenser . . . and (d)—the effect of each filter choke.

Some of the other demonstrations for which this device is used are (1)—Comparison of the input and output wave forms to and from a complete audio-frequency amplifier to check and measure distortion and phase shift. The electron switch is used as an auxiliary in this application. (2)—Comparison of the modulated and unmodulated wave from a radio-telephone transmitter. Positive and negative carrier shift, harmonic distortion, over and under modulation are all demonstrated visually. Measurements for percentage modulation may also be taken from the trapezoidal trace.

With reference to maintenance operations, the oscillograph is invaluable from the standpoint of both the student and the instructor. For instance, the alignment of superheterodyne receivers may be accomplished visually. The amplitude of the output wave from each stage of the receiver is far more understandable than the readings of voltage obtained by means

of a vacuum-tube voltmeter, although the latter cannot be disregarded and must come in for its share of use. In addition, distortion checks on receivers by means of the oscillograph cannot be approached, as far as speed and accuracy are concerned, by any other instrument, showing as it does double peaks, ultra-sharp resonance curves, etc. When used for maintaining the high quality of emission from radio-telephone transmitters, the oscillograph finds so unique a place that it is usually incorporated as a permanent indicator on the transmitter panel. Students in the maintenance course may thus be shown easily how the fidelity of emission is affected by over-modulation, and over and under excitation from previous radio frequency amplifiers.

Among the unusual airline instruments prospective students must become familiar with are such units that have been developed for two way operation and operate in the band of 2.5 to 12 megacycles. Another unit, known as a local two-way, operates on the ultra-high frequency band of 140 to 143 megacycles. The student will find that the 2.5 to 12 megacycles band is used because it provides medium distance coverage for communications with ground stations and also provides long distance coverage so that the plane may communicate directly with the dispatch center. Available channels in the high frequency band will permit the selection of the channel best suited for specified coverage with due consideration to the day and night as well as the seasonal characteristics of high frequency distribution.

Ultra-high frequency channels are used for local communications. This service is well suited for communications near the airport and will cover the operation of landing and take-off communications. Since on the 140 megacycle band, transmission is limited to the optical path, a great reduction in airport noise is also realized. In addition the reduction of atmospherics on ultra-high-frequencies as compared with the high frequencies is of great value in maintaining consistent communication.

In addition to being taught that communication with the airline ground stations requires these various channels, students are also shown that there are certain channels designated for the purpose of contacting, for instance, the airport traffic control tower. This is an important topic of study since these channels are vital to the procedure of systematic arrival and departure of traffic.

Among the radio navigational aids on board an airliner that receive strict attention by the students are the beacon receivers, direction finders, automatic compass and marker receiver. This equipment is used in conjunction with such ground facilities as the simultaneous range station. This transmits a directional beacon signal and at specified intervals weather reports are voice transmitted with the

beacon signals. These stations operate in the 200 to 400 kilocycle band. Actually the range station consists of two transmitters. One transmitter is alternately connected to one of the two sections of a modified antenna . . . known as the Adcock antenna. The input to one antenna is keyed "A" while the other is keyed "N." This keying is done in such a manner that the A and N interlock in the equi-signal zones, resulting in a continuous tone. At intervals of 30 seconds, an identifying signal, which designates the name of the station, is transmitted first on the antenna that is keyed "N," and second on the antenna that is keyed "A." We thus see that alertness again becomes an important virtue.

Since phone is also used extensively on airline service, the ability to speak clearly is another important requirement of an operator. Accordingly specific courses are given in diction. This training is conducted during regular studio classes as well as during airline procedure study. During this period, recordings of voice are made, so that the student can gauge the quality of his voice.

During regular procedure, messages are fed not only to the code board, but to the standard airline circuit as well. Thus the student becomes completely acclimated to standard airline practice. This method of "actual-service" training is used in all of the classes. Every possible form of message or every type of form is piped through the circuits.

Although the courses usually run from six to eight months, some have completed the course in as little as three months and pass their examination entitling them to a Federal license. One such star stu-

dent was a girl, Dorothy Kaufman, who before attending the school had been a secretary. Her ability was so outstanding that she was accepted in the WAVES, to become a radio technician, after the usual military training.

If there is anyone in doubt as to the enthusiasm of the American man or woman in the airplane and its useful-

ness today, a view of the student body at this school will erase that doubt instantly. There's a determination and interest in every face that shouts . . . we are at work to do a job . . . the American way!

**Buy More Bonds!**

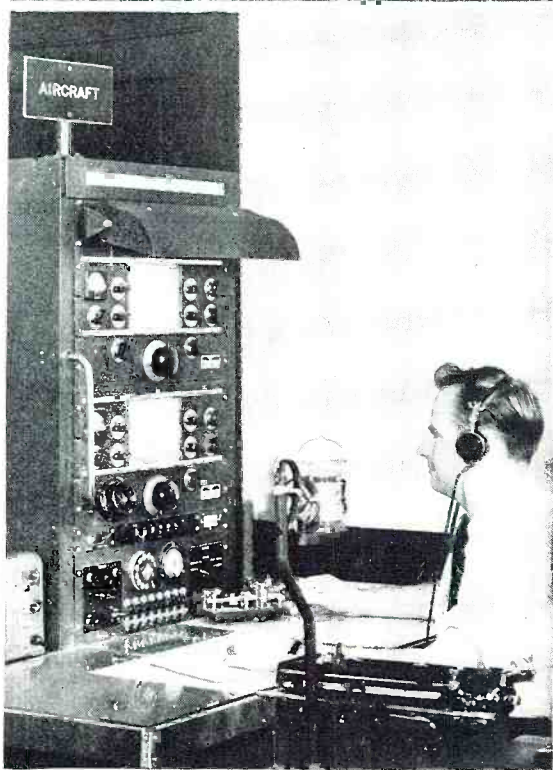
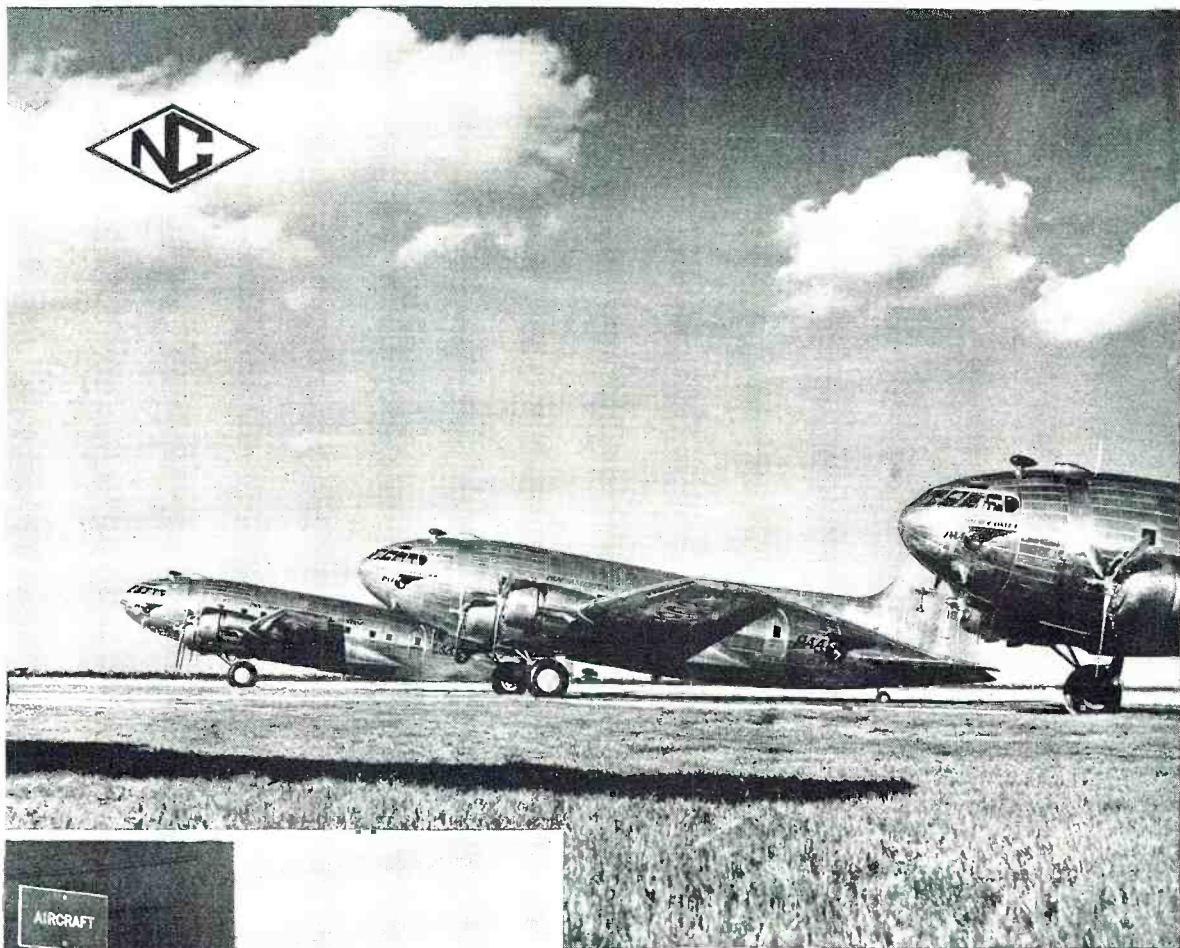

PHOTO COURTESY OF PAN AMERICAN AIRWAYS SYSTEM

Upper photo: Pan American Strato-Clippers.

Lower photo: A Pan American radio installation using National Receivers.

**I**t is not too much to say that Pan American Airways has invented the technique of transoceanic air transport; a technique based on superb skill, meticulous maintenance, and thoroughly reliable equipment.

National and Pan American Airways have never been strangers, but we are particularly proud that year by year Pan American has turned increasingly to National communication Equipment.

**NATIONAL COMPANY, INC.**  
MALDEN, MASSACHUSETTS

# RADIO PARTS BARGAINS!

GUARANTEED ALL PERFECT BUY NOW!

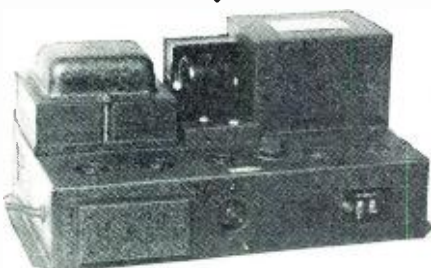

**PHONO-AMPLIFIER**—by well known manufacturer. Push-pull 2A3, 12 Watt. Tube complement 1-56, 1-53, 2-2A3s, 1-5Z3. Supplies current for 1 or 2 2500 ohm fields. Operates on 117 Volt AC 60 cycles. With slight change of volume control can be used with high impedance magnetic or crystal pick-up. Perfect working condition. Schematic furnished. Only **\$7.95 each**



**ASTATIC CRYSTAL PICK-UPS!**—high grade, low pressure pick-up. Statuary brown finish with single hole mounting bracket. Mounting center 7". Plays up to 12" records . . . your new low price . . . . . **\$2.95 each**

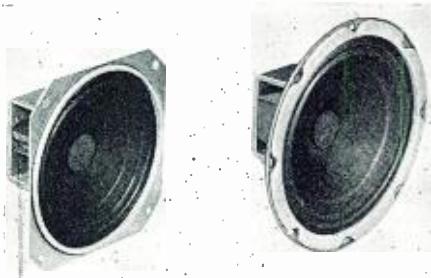

**P.M. SPEAKERS!**—All new—thousands in original cartons. 4" and 5", good heavy construction. V. C. impedance 3-4 ohms. (Less transformers) 4" at . . . **89c each** 5" at . . . **\$1.10 each**

**SERVICEMEN'S SPECIAL!**—10 lbs. Radio Parts Kit. An assortment of controls, switches, coils, variables, resistors, condensers, etc., all perfect and brand new! **only \$2.95**

**SPAGHETTI TUBING** . . . 3 foot lengths . . . flexible . . . red, yellow, green and black . . . 12 lengths . . . . . **\$1.00**

**FREE!** Servicemen write today for free catalog listing thousands of parts bargains . . . hardware and replacement parts.

**WE SAVE YOU MONEY! . . . DROP A POST CARD TODAY**

**RANDOLPH RADIO**  
609 WEST RANDOLPH ST., CHICAGO, ILL.  
"Millions of Parts for Millions of Radios"

## Atomic Physics (Continued from page 30)

path are always the same for a given state even though the individual molecules may have a speed ranging from zero to a very high value. This is because the gas contains so many molecules.

If a molecule or atom of the gas loses an electron or gains an electron, it does not necessarily combine with another atom or molecule to form a compound, but may form a charged atom or molecule called an ion. If the ion is formed by losing an electron, the electron may wander around free for a short time before it is finally captured by another atom or molecule. These free electrons and the resulting positively charged ions are the agents which carry electricity in a gas.

Let us examine the method by which a gas goes from the insulating state to the conducting state. If two plates at a potential difference of the order of a thousand volts are placed the proper distance apart and the current which can flow in the circuit is limited to some small value by a suitable resistance, it will be found that the familiar sparking will occur. The formation of sparks is not well understood. If it is imagined that an ion is formed somewhere between the plates by some process, the electron liberated will move towards the positively charged plate, and the ion will move toward the negatively charged plate. The electrical field will accelerate the electron and ion. When their velocity has become high enough they are capable of knocking other electrons out of other gas molecules, thereby forming more ions and free electrons and these in turn are accelerated and may reach a velocity sufficient to knock electrons from other atoms or more electrons and ions. This is continued until there are enough electrons and ions to carry the current of a spark. This all occurs in less than a millionth of a second. On sparking the potential of the plate immediately falls.

The electrons and ions are no longer sufficiently accelerated to acquire a velocity great enough to maintain the supply of electrons and ions necessary, and the spark is extinguished until the potential of the plates is sufficiently high to again accelerate the ions and electrons rapidly enough. The spark is then again formed.

The length of time between the time the electrodes reach their sparking potential and the formation of the spark depends upon the chance formation of the initiating ion. This ion may be formed by collision with a very fast moving molecule or atom or may be formed by some radiation striking it. It may also be formed by an electron set free from the negative plate by any of the processes mentioned under the discussion of the electron emission from solids being accelerated and

striking the molecules of the gas. It will be seen from this that the spark is not a steady state but rapid transition from an insulating state to a conducting state.

If the electrodes are placed in a gas tight chamber and the pressure reduced until it is approximately one fifth of that of the atmosphere and the amount of current is limited as for the sparks, a continuous conducting state will be found to exist. This is a glow discharge. On examining its appearance, it will be found that it consists of light and dark spaces as shown in Fig. 2. If the potential drop along the discharge is examined, it will be found that almost all of it occurs in the dark space next to the cathode or negative electrode.

The mechanism of the formation of the glow is similar to that of the spark, but since the pressure is low, free electrons and ions have a longer life and, therefore, serve to maintain the glow. The electrons are so much lighter and smaller than the ions that they move much more rapidly. This leaves most of the gas with a positive charge. A glow discharge will not maintain itself if the potential between the electrodes drops below the order of hundreds of volts. This is because there is a minimum value for the cathode drop below which the glow will not maintain itself. But if the external resistance is removed, the glow transforms itself into an arc which is capable of carrying thousands of amperes with a drop of only tens of volts. This means that the cathode dark space has collapsed to very small proportions.

An adequate explanation of this has not yet been found. Gas-filled electronic tubes designed for high voltage, low current will use the glow discharges as a current carrying device. Those designed for low voltage, high current applications will use the arc. An arc will maintain itself at atmospheric pressure.

Below about  $10^{-2}$  a glow discharge is not stable unless some external electron source is provided to keep the remaining gas in a continuous highly ionized state. Below  $10^{-5}$  the glow no longer exists even under these conditions, and the transmission of current must depend almost entirely upon electrons emitted from some solid substance. This is the condition that exists in the high vacuum tubes. The average vacuum tube on the market has a pressure of  $10^{-7}$  mm of mercury. At this very low pressure there are still one thousand million ( $10^9$ ) molecules per cubic centimeter.

A perfect vacuum is still a long ways from being obtained. The best vacuum obtainable still has about ten million ( $10^7$ ) molecules per cubic centimeter. In a high vacuum tube if the difference in potential between the two electrodes is one hundred and ten volts and the electron leaves the negative electrode at zero velocity, it will be traveling at approximately 15 million miles per hour when it reaches

the positive electrode. This is about one one hundredth the speed at which light travels. It is not surprising that when this electron strikes the other electrode that it knocks other electrons out of the metal. It will be well to keep in mind these atomic concepts while reading subsequent articles.

Since most of the electronic devices work at reduced pressures, it will be well to examine the equipment used to remove the unwanted gases. There are only two types of pumping devices in general use today. They are the rotary mechanical pumps and the diffusion pumps. Fig. 3 shows the mechanics of a rotary pump. It will remove the gas down to about  $10^{-3}$  mm of mercury. The operation of this pump is self explanatory. The diffusion pumps depend upon setting up a wall of vapor into which the gas of the system can diffuse in only one direction.

Fig. 4 illustrates a simple diffusion pump. The vapors of mercury and oils are used in the modern diffusion pumps. A jet is formed of these vapors as shown in the figure. The gas molecules in the system to be evacuated can diffuse into the stream of vapor, but after they get into the stream they are carried along and find it difficult to get back into the high vacuum part of the system. The vapor is condensed upon striking the wall as shown in the figure and is returned to the boiler. The gases brought in with the vapor are pumped away by a mechanical pump. Diffusion pumps will not work unless the pressure on the high pressure side is less than a few mm of mercury. They, therefore, have to be backed by some kind of mechanical pump.

Diffusion pumps using oil are capable of reaching  $10^{-6}$  mm of mercury. Mercury vapor pumps have to have a liquid air trap before they can get down that low. This is because the mercury vapor that is not condensed out at the temperature of the condenser will always be present in the system. It can not be removed sufficiently except at the temperature of liquid air. Oil can be carried down to  $10^{-6}$  mm of mercury before its vapor becomes troublesome. Below  $10^{-7}$  mm of mercury a liquid air trap has to be used with oil. An oil pump with a liquid air trap can go down to below  $10^{-8}$  mm of mercury.

The metal and glass parts of the tubes for high vacuum work have such a large amount of gases absorbed on them that they will continue to give up gases for a long period of time unless they are removed. If the parts of the tube are heated three or four hundred degrees above their operating temperatures, enough of the gas will be removed so that it will not be troublesome in subsequent operations if the tube is continuously pumped. The tube will continue to give off gases which, if not continually pumped away, will eventually cause the pressure to become too great.

In order to provide some sort of

continuous pumping arrangement for tubes taken off the pumps, a substance called a getter is used, which absorbs the gases as fast as they are liberated. Getters are usually barium, magnesium or both. The silvery getter deposits on the inside of vacuum tubes are familiar to every one.

\* The method used here to express numbers is a very useful method for expressing very small or very large numbers. For instance,  $1 \times 10^6$  means 1 followed by 6 zeros, i.e., 1,000,000.  $1 \times 10^{-6}$  is equal to .000001. The decimal point has been moved 6 places to the left.

(To Be Continued)

**QRD? De Gy**  
(Continued from page 38)

equipment is being shipped to our fighting forces. Radiomen who are qualified are inspecting and checking a thousand and one items necessary to the communication systems of our army. C. B. Bolvin has vacated his police post at Akron for a billet in Chicago. At San Francisco are men like Johnny Agati, Lieut. Homer Huff, Moseley, Scribner, Gil Severn, Williams; at Los Angeles, Stephenson, Bob Barbley, Chambers, Caldwell, Reig, et al. On the East Coast there



## "Certainly, I'd Rather Wear Nylons

★ ... but if the boys at the front need it for parachutes, I'm happy to do with this 'little less' until the war is won."

★ Your customers will be equally understanding in their radio repair work, where the shortage of replacement parts may force you to improvise repairs in order to get a set into operation.

★ This improvising may require the total elimination of certain stages, or the substitution of specific resistors, condensers, sockets, etc., and, as a result, the finished job may not be "100%". However, if you explain to your customers how you have gotten around an "impossible" situation, they will appreciate it and be satisfied with a "little less" than perfection while the armed forces are in need of radio parts. By this improvising, you will be meeting your responsibility to "keep 'em playing" and doing your share toward winning the war by conserving parts.

★ To know just what section can be eliminated—what parts can be by-passed—what replacements can be substituted for—you have to know what is in the set. It isn't profitable to spend hours "guessing" where the set is defective and "experimenting" with "probable" methods of improvising repairs. The servicing data in RIDER MANUALS can lead you right to the trouble, and furnish you with the facts that will enable you to get the set into operation quickly, in spite of material shortages. So, reach for one of your Thirteen RIDER MANUALS when you begin every job! It's your duty to work with the utmost efficiency.

### RIDER MANUALS

★ Volumes XIII to VII.....\$11.00 each  
★ Volumes VI to III..... 8.25 each  
★ Volumes I to V Abridged.....\$12.50  
★ Automatic Record Changers and Recorders.. 6.00

### OTHER RIDER BOOKS YOU NEED

★ The Cathode Ray Tube at Work.....\$3.00  
★ Frequency Modulation ..... 1.50  
★ Servicing by Signal Tracing..... 3.00  
★ Meter at Work..... 1.50  
★ Oscillator at Work..... 2.00  
★ Vacuum Tube Voltmeters..... 2.00  
★ AFC Systems ..... 1.25  
★ HOUR-A-DAY-WITH-RIDER SERIES—on "Alternating Currents in Radio Receivers"—on "Resonance & Alignment"—on "Automatic Volume Control" on "D-C Voltage Distribution."  
★ 90c each

### JUST OUT!

★ A-C CALCULATION CHARTS—Two to five times as fast as a slide rule—and more fool-proof. All direct reading—operative over a frequency range of from 10 cycles to 1000 megacycles. 160 Pages—2 colors—9½x12 inches.....\$7.50

### FOR EARLY PUBLICATION

★ Inside the Vacuum Tube—complete elementary explanation of fundamentals of vacuum tubes.

★ **JOHN F. RIDER PUBLISHER, Inc.**  
★ 404 Fourth Avenue, New York City

★ Export Division: Horke-International Electric Corp.,  
100 Varick St., New York City • Cable: ARLAB

★ **YOU NEED ALL THIRTEEN  
RIDER MANUALS TO "CARRY ON"**

**SAVE MONEY ON—  
CABINETS, RECORDERS,  
CHANGERS, and RADIO PARTS**

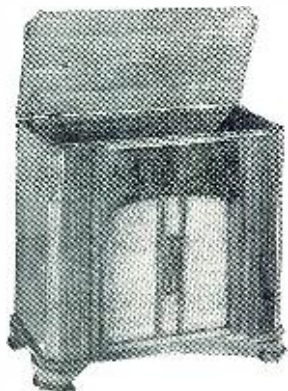

**OXFORD TYPE PD.** A beautiful hand-rubbed, piano-finished cabinet. Made of five-eighths stock. Rose Mahogany and Walnut. A real piece of furniture 33" high, 32" long, 17" deep. Phono compartment 31 x 15 x 6"..... **\$2695**

**LAKE HAS THEM!**

Complete assortment of all replacement parts for the GRUNOW radio sets. These duplicate switches, voltage dividers, speakers, volume controls, coils, resistors, condensers, wet electrolytics, output transformers, chokes, dial parts, etc., are available only at LAKE. **50% off list!**

**Speakers**

14-inch Nationally advertised dynamic speakers—900 ohm field with 6F6 push-pull output transformer. \$4.00 each in dozen lots; singly only..... **\$450**



**Deluxe Changer**

Ideal for small cabinets. Only 12" x 13" x 4 1/2" high. Plays 10 12" or 12 10" records. Crystal pick-up, offset record suspension, reject switch, smooth action..... **\$1295**

**Victory Special . . . — . . . — V**

**NATIONALLY-KNOWN, HEAVY DUTY MOTOR.** Silent, dependable, induction type, self-starting motor; 9" turntable, 78 RPM. Enclosed gears. For 110 v. 60 c. \$11.50 List. **\$465**  
Now only.....

New Bargain Bulletin Arouses Nation! Gigantic money saving values help Servicemen, Jobbers, Radio Dealers and Sound Men . . . Everyone can save money and help "Keep 'Em Listening" . . . Everybody can improve their business this easy, money saving way. A new cabinet or a new combination radio and phonograph will help make any home a better place to live in. We also save you money on all radio parts. **SEND NOW FOR NEW FREE BULLETIN.**

**LAKE RADIO SALES CO.**  
615 W. Randolph St. Chicago

are hundreds of others who as yet, unable to get into combat duty, find this a chance to help out in our war effort. The work they do is a military secret and the winning of this war depends on them to a great extent. Viva Inspectors!

**A**ND speaking of Johnny Agati, that sawed-off handful of dynamite will be remembered by some of the old-timers as the radiop who stuck to his post in spite of the "three star H," and we don't mean Three Star Hennessy. Here's one of the writeups from the Nome Nugget on that occasion. Quote the owners of the schooner Fred J. Wood are fortunate indeed to have a man who will attend to his duties in such a commendable manner as did radiop John Agati during the late storm in which the Schooner Wood was driven on the beach.

Agati stood by his ship during the impending danger and sent radio messages to the local radio station. When his engine, which drives the dynamo attached to the radio set on the schooner, became wet from the water coming aboard the grounded vessel, Agati arranged the engine so it would operate and furnish power for the radio set to keep in communication with the Nome station. Sgt. Anderson at the local station stated that assisting the radio station here in keeping communications with his vessel under such adverse conditions was a very commendable act unquote.

Johnny still wears a small size hat which is the reason the Army Signal Corps is expecting to do big things for him.

**A**NENT a previous paragraph we quote a letter from Brother Halpin from Saugus, Mass., Quote . . . It seems they don't want anyone in the — — — or any other branch unless he knows higher mathematics. I have had 18 years of radio servicing. All during this time I have studied everything I could get on theory and practice of radio servicing receiving sets. I can work any problems regarding impedance using algebra or trigonometry. My eyesight was 20/20, hearing perfect, physical condition good (I am 51 years of age) but the officer in charge after trying to stick me on various problems finally asked me if I could do calculus. I told him I could not and right there and then his interest in me waned. I might also mention that I have had over ten years in the care and maintenance of power station equipment of all kinds. I attended a night and day school in Boston for over five years on a.c. and d.c. problems and apparatus; but I could not do calculus so all is lost so far as I am concerned. I suppose I should not cry on your shoulders but your article happened to fit my case. . . . It seems to me that if some one in charge knew about the men who are willing to serve and have the ability to service and maintain their equipment they at least could be used in this capacity.

The — — — must have thousands of sets that need servicing and not engineering . . . unquote. Services please note. This man's address can be had on request.

**A**NOTHER beef comes from Havana, Cuba (Yeh, RN does get around in spite of wars, earthquakes or depressions) from Brother Ulpiano Muniz, who complains, and rightly too; that inasmuch as our article a few issues ago stated that we are short of radiops, and inasmuch as his country cannot use him because of the lack of vessels, and inasmuch as he is a top-notch radiop, whyinell is it necessary for him to become a citizen to get a telegraph ticket for ship operating when Cuba is also at war with the common enemy and his services could be used? That guy has something there and we are wondering whether some sort of exchange deal couldn't be made between this country and our Latin neighbors for radiops. We are all one united nations and as we are the shipping center for supplying most of these nations wouldn't it seem practical policy to use radiops of our allies to man our ships whenever we are short radiops? Just an idea as we skip along. But it may be a germ that may germinate. Who can tell? Vamos a ver.

**N**OW that investigations are becoming more frequent and more direct it is a word of advice to those who are on the fence of decision as to which form of government they'd rather have, to make up their minds fast . . . but right now. It is about time that drastic action was taken to prevent sabotaging the war effort. And it is about time Washington stopped manufacturers, political heelers and just hangers-on who want a slice out of the "pork barrel" from doing likewise. We are just about set to go "all-out" and we expect that by our next issue we'll be able to report some definite progress towards this goal. So with a cheerio and chins up . . . 73 . . . ge . . . GY.

—50—

**Practical Radio**

(Continued from page 33)

rection only as shown by the illustration.

These individual rectified radio frequency current pulses occur too rapidly to affect the earphones since their windings offer a very high impedance to currents of such high frequency and their diaphragms offer too much inertia to such rapid movement. These individual radio-frequency current pulses charge condenser  $C_2$ , instead, and since they are continually varying in strength in accordance with the modulation of the signal, the potential existing across the terminals of the condenser is constantly varying in accordance with the modulations.



This causes audio frequency currents varying in strength in accordance with the modulations to flow around through the circuit comprising condenser  $C_2$  and the earphones, as shown (since current cannot flow back through the crystal detector rectifier). The motion of the earphone diaphragm, and the sound produced by it, therefore follows this audio-frequency modulation. The sound produced at every instant is a faithful replica of that acting on the microphone in the transmitting station at that instant.

The operation of this same simple detector circuit for the reception of "keyed" interrupted continuous waves (ICW) is illustrated in Fig. 7. Here again, the individual rectified radio-frequency current pulses occur too rapidly to affect the earphones. The audio frequency currents varying in strength in accordance with the modulations do flow through the earphone windings, and the motion of the diaphragm, and the sound produced by it follow these. Hence if the modulations or interruptions to the continuous wave are at the rate of 1,000 per second (the usual rate) a 1,000 cycle tone will be heard in the phones. This tone will be broken up in accordance with the dot and dash code message being received.

#### Need for Amplification

The radio receiver just described, when reduced to its simplest components consists of:

1. A signal tuning or selector circuit.
2. A detector, or rectifying current.
3. An electroacoustic translating device for translating the audio signal currents into corresponding sound waves.

One of the serious limitations of this type of circuit is that the receiver output energy in the form of sound waves can never be greater than the minute amount of energy collected from the passing radiations by the receiving antenna system. In fact, it is always less than this value because of electrical losses which occur in the various components and circuits in the

receiver and because of electrical and mechanical losses in the earphones. Consequently this simple circuit is limited to the operation of earphones and reception of nearby stations.

In order to make loudspeaker reception of weakly received stations possible some means must be provided for amplifying the weak signal voltages induced in the antenna circuit so that they may be built up to the required strength. The vacuum tube, which we shall study next, provides just such amplification. In fact, as we

shall see later, the vacuum tube is also used in modern radio receivers to act as the detector in the circuit.

*(To Be Continued)*

**Better hurry if you failed  
to get a copy of the Nov.  
Signal Corps Issue!**



*We're "nuts" about our*  
**UTC SUBMERSION  
TYPE COMPONENTS**

YES . . . we are proud of our Submersion type units. They are now available in a wide range of sizes to cover practically every requirement in defense and non-defense applications.

These units are designed to take the most extreme of Navy tests, which consist of five complete submersion cycles under salt water over a very wide range of temperatures.

The same engineering development which perfected these units can be applied to the solution of your transformer problem.

*May we have an opportunity to cooperate?*

**UNITED TRANSFORMER CO.**  
150 VARICK STREET ★ NEW YORK, N. Y.  
EXPORT DIVISION: 100 VARICK STREET NEW YORK, N. Y. CABLES: "ARLAB"

## Emergency Portable

(Continued from page 28)

250 ohm, 25 watt dropping resistor or filter. We found that it was not necessary to employ a filter choke, sufficient filtering being obtained from the R.C. network to remove whatever ripple remained.

There is no reason why a conventional power supply could not be employed for fixed operation, except that it would be necessary to employ a separate battery to supply the microphone current.

Other details are self-explanatory and need no further discussion. This

portable unit will be found to be highly efficient for W.E.R.S. traffic, and its compactness will aid greatly for emergency work where quick setups are required. The operator should provide himself with long heavy braided copper leads, and these should terminate to heavy type battery clips.

The name plates shown on the illustration were made by lettering on to bristol board and having a negative "stat" made the proper size. Strips are made and cemented to the panel as shown. Many photographers are able to do this type of work, and the portable involved results in a neat appearing unit with all identifications clearly indicated.

-50-

## Electronic Time

(Continued from page 25)

and apparent equinoctial time (*side-real time*), a maximum value of a little over one second, is due to *nutation*, the nodding of the earth's axis, a process resembling and comparable to the nodding of a spinning top. Because this difference is so small, astronomers generally use sidereal time. Sidereal time is convenient for rating standard clocks but is not suited for general public use, so the mechanism for transmitting time signals to the public is rated to mean solar time. Recently, a few observatories including the U. S. Naval Observatory have begun to employ mean equinoctial time in computing the rates of their precision clocks.

Various parts of the world necessarily have different solar times, since the sun does not cross the meridian at the same time in different parts of the world. Standard time zones have accordingly been set up in order to reduce confusion. The boundaries have been placed where they will create the least amount of inconvenience, rather than along exact meridians, since small sections of certain districts would otherwise be compelled to use different time than their neighbors and railroad operators would be required to make time changes at inconvenient points rather than at termin- als.

The uniform time used by all points in each zone differs from the actual time at those points by not much more than half an hour and is almost identical in some places. The zone times generally differ from Greenwich (zero-meridian) time by some whole number of hours.

The four time zones in the continental United States—Eastern, Central, Mountain, and Pacific—are explained by the U. S. Naval Observatory in the following manner: "Eastern standard time is the local time of the 75th meridian and is five hours less advanced than Greenwich time. Central standard time is the local time of the 90th meridian and is six hours less advanced than Greenwich time. Mountain standard time is the local time of the 105th meridian and is seven hours less advanced than Greenwich time. Pacific standard time is the local time of the 120th meridian and is eight hours less advanced than Greenwich time. The time signal sent out by the Naval Observatory at 3 a.m. Greenwich Time serves as 10 p.m. EST; 9 p.m. CST; 8 p.m. MST; and 7 p.m. PST."

### U. S. Naval Observatory

The Naval Observatory had its inception in 1830 when the Depot of Charts & Instruments was established by the Secretary of the Navy. It is one of the missions of the Observatory "to derive, maintain, and disseminate the most accurate time for the national use," and this mission it has ful-

When Space is at a Premium

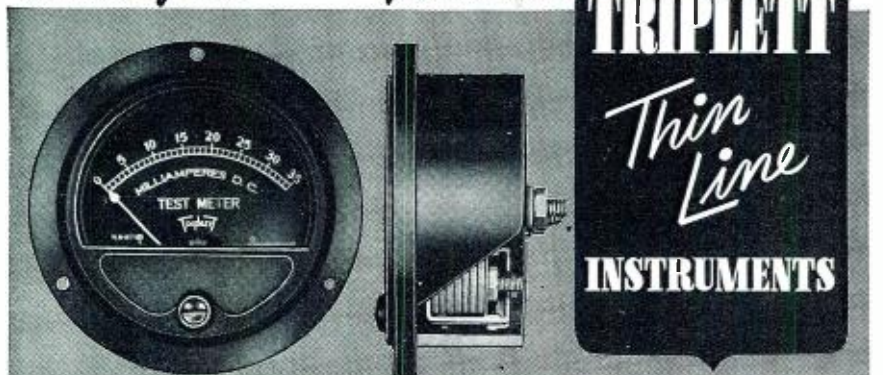

Full size of instrument. Note deep shroud for glass protection and "Quick-Look" Scale.

This molded case contains full size Triplet Mechanism. Rugged Construction. Compact Convenience.

### THIS IS THE INSIDE STORY

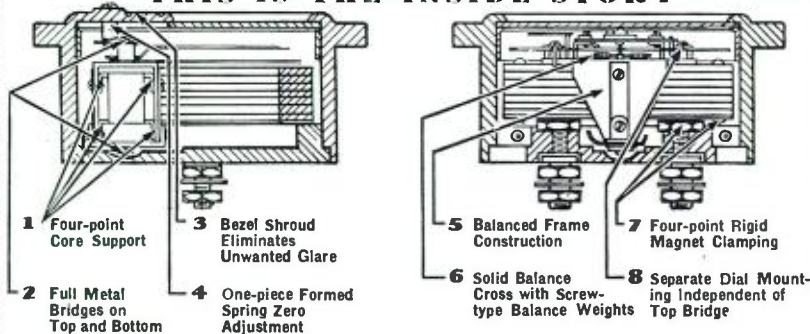

Thin-Line Instruments also have Standard Large Coil Triplet Movements. Furnished with Osmium pivots for special requirements. All these features make for greater rigidity under vibration; greater permanence of calibration; greater user satisfaction.

Triplet Thin-Line Instruments meet rigid requirements for dependable performance. Though occupying minimum space they are *not* miniatures. Mechanisms are standard size with emphasis on excellent performance over long periods. Standardized installation. Made in three styles of cases—Molded, Metal Wide Rim and Metal Narrow Rim.

Triplet Thin-Line Instruments, available for many industrial applications, can be depended upon for precision performance in limited space. For full details write for "Triplet Thin-Line Bulletin."

THE TRIPLITT ELECTRICAL INSTRUMENT CO., Bluffton, O.

filled for a great many years.

The Naval Observatory has used for time determination small transit telescopes, mounted rigidly to avoid vibration and pivoted so as to be rotatable from north to south along the meridian, but not to the east or west. Through these instruments, a heavenly body is visible only when it is near the celestial meridian, an imaginary line in the sky drawn through the *zenith* (the point in the heavens directly overhead) from exactly opposite points on the northern and southern horizons.

The stars selected for sighting cross the meridian near the zenith at Washington, D. C. By previous calculations, the sidereal time at which each star will cross the meridian is known. Observation of the sun and stars regularly over a period of several years show their relation very accurately. And the results of these observations have been correlated to obtain data for making calculations to reduce a single night's observations.

Formerly, the observer operated an electrical switching device, such as a pushbutton, to signal the passing of a star past certain points in the field of the telescope. Such signals were recorded by a chronograph on a record sheet along with ticked impulses from a standard clock. As a result, the error of the clock was indicated by the difference between the instant at which the stars were predicted to cross the meridian and the clock time at which they were observed to cross. This difference is determined by making measurements on the chronograph sheet and correcting for several errors of the telescope. A number of selected stars are observed on one or more telescopes during each clear night, to provide a continuous record of standard-clock corrections.

This manual system of signalling a star passage is necessarily subject to some degree of human error. And the Naval Observatory has done pioneer work in the last few years in the photographic determination of the instant of star passage. Comparatively recently, there has been put into service there a new type of telescope for the purpose, the *photographic zenith tube*, which is shown on page 23. This instrument is fixed rigidly in a vertical position to photograph only those heavenly bodies that pass very near the zenith.

Light rays from a star pass through a lens at the top of the "tube" and is reflected from the surface of a basin of mercury at the bottom so as to be brought to a focus upon a small photographic plate placed just under the lens. The lens and the plate may be tilted as a unit through a small angle without appreciably changing the position of the image on the plate. This is due to the lens curvature and the position of the plate.

The plate is driven from west to east to keep pace with the motion of the passing star's image, and automatic instruments record the clock

time at which the plate is in certain positions. Impulses from the photographic zenith tube are received by a chronograph along with tick impulses from a standard clock. The times of meridian transit are deduced by measuring on the exposed and developed plate the distances between the non-coinciding star images before and after reversal.

With the photographic zenith tube, the clock time may be determined within one thousandth of a second. The clock error is ascertained by comparing the star transit time, as indicated by the clock, with the predicted time obtained from the Nautical Almanac.

Standard clocks at the Naval Observatory are rated to run on sidereal

time, since the times of star transit are more readily computed on that basis. These clocks are specially manufactured for precision purposes and are never reset or disturbed in any manner unless repairs are needed. The Observatory says "The actual rates of these clocks are not important as long as they are constant, or as long as they change slowly enough to be checked by astronomical observation. The short-period variations in the rates of the present standard clocks are such that on an average the clock rates may be predicted within about a hundredth of a second per day."

The Naval Observatory has six standard clocks. Until recently they were all made by *Riefler*. Considerable research has been carried on late-

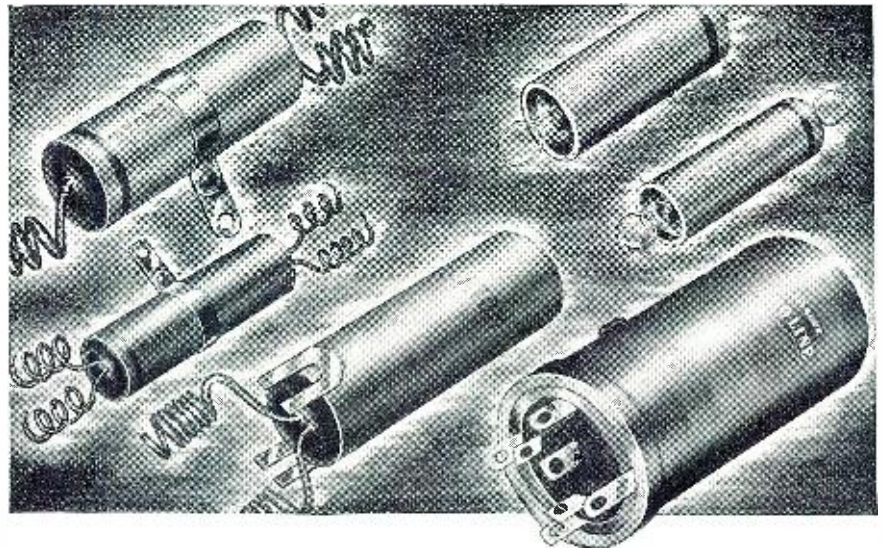

## WHO SAID ANYTHING ABOUT CONDENSER SUBSTITUTES?

Even if restrictions on metals hadn't eliminated aluminum can type electrolytic condensers . . .

Even if War demands on leading manufacturers such as Sprague hadn't made it necessary to simplify condenser lines and curtail many "exact duplicate" and other types . . .

The fact remains that leading servicemen would now be using Sprague Atom Midget Drys and Type EL Prong-Base Drys almost universally, anyhow. For these Condensers are definitely *not* substitutes. They're a big forward step in modern condenser construction. A small stock enables you to replace almost any condenser of equal rating—and do it in less space, at less cost, and with every assurance of better, more dependable performance. Drys or wets, low voltage or high voltage, single capacitors or duals or triples —Atoms and EL's handle them all.

As long as your Sprague jobber has these popular units, you've no need to worry about condenser replacements . . . and you won't be using substitutes. You'll be using condensers that are actually better—condensers that will set the style in efficient servicing for years to come!



**SPRAGUE** PRODUCTS COMPANY  
North Adams, Mass.



*"Still Doing Business  
at the Same Old Stands"*

## SERVICEMEN

... your Distributor can  
**STILL** Supply you with

# Centralab

## MIDGET RADIOHM REPLACEMENTS

Fortunately . . . your distributor can still supply you with Midget Radiohms for replacements.

The smooth wall-type resistor for which Centralab Radiohms are famous will keep that now-precious radio in good working condition.

Stick to **OLD MAN CENTRALAB** for Replacements . . . and always specify "CENTRALAB".

- RADIOHMS • FIXED RESISTORS
- FIXED AND VARIABLE CERAMIC CAPACITORS
- SELECTOR SWITCHES

**CENTRALAB:** Div. of Globe-Union Inc., Milwaukee, Wis.

*Built in Precision*



MC5  
By Bliley  
27320 KC  
MADE IN U.S.A.

Accuracy and dependability are built into every Bliley Crystal Unit. Specify **BLILEY** for assured performance.

**BLILEY ELECTRIC CO.** Erie, Pa.

### RADIO & TELEVISION WAR TIME OPPORTUNITIES

In armed services and war industry. Real peacetime **FUTURE** state licensed. Call daily 9-9, Sat. 9-2, or write department R.N.

**RADIO-TELEVISION INSTITUTE**  
480 LEXINGTON AVE.  
NEW YORK CITY  
Telephone Plaza 3-4585

*Quality above all*

## SOLAR

CAPACITORS

SOLAR MFG. CORP. BAYONNE, N. J.

ly, however, notably by the English firm which produced the well-known *Shortt* clock, to provide improved standard clocks. Quartz clocks have also appeared and are finding application in a number of places. These depend upon the constant vibrations of a low-radio-frequency quartz crystal in a vacuum-tube oscillator for their time standards. Radio and electronic research workers are familiar with the principle of this type of clock, encountering it as they do in primary radio-frequency standards.

The Observatory's standard clocks are housed with great care. They are maintained under conditions of constant temperature and constant pressure in an underground vault (which is actually composed of two vaults, one inside the other) and are mounted on concrete piers separated from the rest of the building to reduce the effects of vibration. They are visible to operators and visitors through a periscope lowered through the roof of the vault. Lighting is projected into the vault from outside in order to eliminate the effects of self contained lamps.

The Observatory has for 38 years transmitted standard time signals through naval radio stations. A few standard broadcast stations, privately owned in various part of the Country, have re-broadcast these signals under special authorization of the *Federal Communications Commission*.

The error of the apparatus used at the Observatory to transmit the radio time signals is determined with the chronograph by comparison with standard clocks, and corrections are made immediately before the time signals are sent out. "Allowance is made for the continuously changing difference between sidereal and solar time and also for the error of the standard clock," says the Observatory. Apparatus at the Naval Observatory automatically controls the radio stations primarily transmitting the time signals. When NAA was in operation at Arlington, Virginia, the Annapolis and Arlington stations were controlled by land wire; the naval station at San Francisco by radio.

Chronographic records made at the Observatory during the transmission of each signal show the time at which the signal leaves the Observatory and the actual time of its emission from the naval radio stations. By making measurements on the chronograph-sheets, it is possible to determine the actual time of radio emission according to the standard clock. The average error of the time signals is computed again by correcting the standard clock, using the star sights both before and after the signals. The average error of the time signals, as sent from the government radio stations, is indicated by this method as approximately two hundredths of a second. The error computed in this procedure may be subject to a further correction of approximately one hundredth of a second, as comparisons of time signals

transmitted by fourteen different national observatories would indicate. Time signals from foreign observatories are recorded regularly at the Naval Observatory.

Time signal correction sheets covering one week of transmissions may be obtained free of charge by individuals whose work requires accuracy of a hundredth of a second. But for ordinary commercial and navigational purposes, the time signals are sufficiently accurate as transmitted.

In 1930, the Naval Observatory was broadcasting time manually three times daily with an accuracy of one hundredth to two hundredths of a second. Its present automatic transmissions, made twenty times each day, have an accuracy of one thousandth of a second. The automatic set-up comprises a crystal clock, chronograph, and automatic keyer.

#### The Elgin Observatory

Outstanding among the Nation's privately-owned and privately-conducted time-standardizing astronomical observatories is that of the *Elgin National Watch Company* at Elgin, Illinois.

At this observatory, the observer looking into the telescope sees two horizontal and eleven vertical wires (metallized spider webs) cutting the field of vision. They are spaced seven thousandths of an inch apart, and a star appears as a bright spot that moves between the horizontal wires. The observer depresses an electric key at the instant when the star is observed to pass one of the vertical wires, recording the time of passage on the chronograph shown on page 24.

The *Elgin Observatory* has four *Riefler* standard clocks (See Page 24) mounted on concrete piers separated from the rest of the building and wound electrically every thirty-six seconds. Two of these clocks are sealed in partially exhausted glass jars and are kept at uniform pressure. They are regulated by changing the air pressure, a very fine method when it is considered that a change in pressure of 1 millimeter changes the rate of the clock eighteen thousandths of a second in twenty-four hours. The clock vault, heated by fifty-four electric lamps, is kept at the constant temperature of 81 degrees Fahrenheit by a thermostat which switches these lamps and is actuated by a temperature change of only one thousandth of a degree Fahrenheit.

The *Elgin Observatory* transmits standard time on short radio wavelengths through one of its own experimental radio stations, W9XAM; and transmits standard radio frequency signals, based upon and corrected by means of standard time, through its other experimental radio station, W9XAN.

#### Western Union

"The Naval Observatory," says officials of the institution, "has no special agreement with any telegraph

company, but furnishes time signals free to all firms and individuals who provide wires for the purpose to the transmitting room."

In August, 1865, the Observatory took its first step in the broadcasting of time, utilizing the wires of Washington's then new and highly-prided telegraphic fire alarm system. The Observatory was connected directly to the central fire alarm office, and the fire bells were struck at 7 a. m. and 6 p. m. by the Observatory.

At the *State Department's* request, a special line was run to its building to provide time signals for that government department. It so happened that the *Western Union Telegraph Company* had an office in the State Depart-

ment building, and the alert telegraph operator on duty there conceived the idea of and immediately began transmitting a private signal to his company's central office in the city each time he received a time signal from the Observatory. "This," the Naval Observatory discloses, "is the origin of the Western Union company's connection with the Observatory, which has continued."

During the early history of the undertaking, Western Union transmitted Naval Observatory time to a few important railroad and business centers. The present time service was not established, however, until 1886 when the first trial circuit was placed into operation in Chicago.

# MEISSNER Signal Shifter

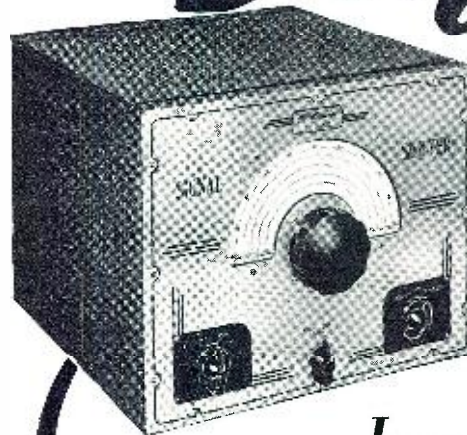

—now incorporates  
extended frequency  
range from  
1,000 kc. to 16,500 kc.

**Install the Meissner Signal Shifter and your crystal procurement problems are solved! The Signal Shifter provides continuous coverage of a frequency range from 1,000 kc. to 16,500 kc. without any sacrifice in stability . . . NO CRYSTALS REQUIRED!**

The Meissner Signal Shifter is a variable frequency exciter of exceptional stability . . . may be used alone as an auxiliary or "Short-Haul" C-W transmitter. All tuned circuits are ganged—controlled by a high quality precision vernier dial.

**THE MEISSNER SIGNAL SHIFTER PERMITS INSTANT FREQUENCY CHANGE IN ANY GIVEN BAND . . . RIGHT FROM THE OPERATING POSITION!**

For further details see your Meissner distributor or write

*Meissner*  
M. T. CARMEL, ILLINOIS

"PRECISION BUILT PRODUCTS"

Western Union has supplied the correct time now for more than fifty years. Its nation-wide service now reaches 2,000 cities connected by 200,000 miles of wire, and Western Union clocks (page 25) are today the most familiar time standards known to the general public. Seventy percent of the broadcasting stations in the United States use Western Union time service.

The distribution of time by Western Union falls into three classes: (1) re-transmissions to railroad offices and telephone companies of the noon time signals originated by the Naval Observatory, (2) time beats furnished throughout the day from 8 a. m. to 5 p. m. to jewelers and watch inspectors, and (3) the most familiar service—the transmission of hourly checking signals to self-winding clocks installed and maintained by the Company on the premises of subscribers.

High-Grade master clocks, synchronized with Naval Observatory time signals, are installed and operated in Western Union offices in all important cities; and once each hour all clocks in each local time circuit are checked against these master clocks, one of which is shown on page 22.

#### Acknowledgement

The author takes this opportunity to acknowledge with appreciation the kind assistance and cooperation of the following parties in furnishing reference material for the preparation of this article:

1. Captain J. F. Hellweg of the U. S. Naval Observatory for a reprint of his article *The United States Naval Observatory* from Vol. 62, No. 10; *U. S. Naval Institute Proceedings*; for various *Observatory bulletins*, and for official photographs.
2. Mr. Frank D. Urie of Elgin National Watch Company for Elgin publications and photographs.
3. The Department of Records & Research, Western Union Telegraph Co. for numerous articles, reprints, bulletins, publications, etc. of that company, and for photographs.

-30-

### Progress in Electronics

(Continued from page 21)

the article, only two are necessary for all circuit computations, but both of these must be satisfied independently. These are:

$$\frac{C_2}{C_1} = \frac{R_1}{R_2} \left( 1 + \frac{R_2}{R_p} \right)$$

$$\frac{C_1}{C_2} = \frac{R_1}{R_2} \left( 1 + \frac{R_1}{R_p} \right)$$

$R_p$ , of course, must be known; it is the plate resistance of the input amplifier tube.  $R_1$ ,  $R_2$ ,  $R_3$ ,  $C_1$ , and  $C_2$  may be known, or may be assigned to suit the circuit under construction.

The other two formulae, though in-

teresting, are not given here, for they deal with the calculation of  $E_1$  and  $E_2$  when the voltage across the common plate impedance is known, and take into consideration the frequency—which, according to the author, does not affect the balancing of the circuit.

Earlier in this article, mention was made of the experiments of Tesla; now comes an invention that harks back even farther, to Hertz, the discoverer of the so-called Hertzian wave, sometimes called the "Father of Radio." You may call to mind the rings which Hertz used in some of his work. These have re-appeared in a patent recently granted to Peter Neihardt, of Berlin, Germany—a patent now vested, it is pleasant to record, in the United States Alien Property Custodian. It is another means of directing ultra-short waves, and would appear to be simpler and cheaper to manufacture than the methods discussed a few paragraphs ago. It consists merely of a pair of rings mounted concentrically and in the same plane. Their diameter is equal to  $1/6$  a wavelength, as is the feeder; the distance between them equals  $0.02$  wavelength. One ring is closed; the other has a portion cut away, the aperture being equal to  $0.032$  wavelength. The opening is pointed in the direction in which maximum wave propagation is desired.

In analyzing the theory of this arrangement, one may make reference to the magnetic field about the poles of a horseshoe magnet: the lines of force "bulge" at the gap. As a transmitting antenna is merely a radiator of electro-magnetic waves, the same sort of "bulge" may be expected at the gap in Herr Neihardt's ring.

No data, of course, is given as to any actual field or laboratory tests made with this arrangement, but it appears to be operable, though there would seem to be considerable question as to its efficiency, compared to that of American directive systems. For a study of the device indicates that the directive effect would be bi-lateral, the areas of maximum service being not only in the direction taken by a diameter produced through the opening in the split ring, but also at a 90-degree angle to that direction along a line drawn at right angles to the complete ring and passing through the aperture of the split ring.

If one may digress for a moment, the design of "second-best" apparatus seems to be a field in which the German mind is particularly facile. Although those people have made some important contributions to science, especially in the field of chemistry, they do not appear to have made any major contributions to the art of communications. The writer, until foreign correspondence was interrupted by the entrance of the United States into the War, made a regular study of all leading foreign radio publications. For many years little of importance came from France or Italy; major strides in television were made in England, and some circuit developments came

TRANSMITTING

AND SPECIAL PURPOSE TUBES

including

THE LATEST TYPE OF HIGH FREQUENCY TUBES

such as:

832 • 829 • 615 • 114B • 813 • 1201 • 1203A

A COMPLETE LINE OF TRANSMITTING TUBES IN ALL IMPORTANT SIZES UP TO 200 WATTS

for your ELECTRONIC tubes • parts • supplies

SEE YOUR LOCAL NATIONAL UNION DISTRIBUTOR

EVERY research department today is working with electronic principles. NATIONAL UNION DISTRIBUTORS handle National Union Radio tubes and allied products. They specialize in radio and electronic items and you will find their stocks very complete. Call or write your N.U. distributor for his industrial catalogue. If you do not know his address send your letter to us and we will forward it.

Transmitting tubes, panel lamps, dry batteries,

cathode ray tubes, exciter lamps, sound equipment,

Heat light bulbs,

photo electric cells, condensers,



**NATIONAL UNION RADIO CORP.**

57 STATE STREET, NEWARK, NEW JERSEY

from the Scandinavian countries, particularly Denmark. Occasionally something of interest would appear in a German publication, but it was invariably "ingenious" rather than "important." Considerable development was seen in Chinese radio, but the Japanese publications limited themselves chiefly to reporting and analyzing what had been done in other countries—especially America, for years the center of electronic progress.

Television, which was born in England through the early demonstrations of John Logie Baird, was broadcast regularly in the British Isles and America until the War forced its curtailment. Though French and German publications spoke of those countries' broadcasts almost incessantly, the writer has yet to meet a Frenchman or a German who actually saw a television broadcast before coming to America. The United States doesn't talk much—but she does the job.

Just prior to our Pearl Harbor episode, considerable attention was being devoted to color television. Demonstrations, described in this and other periodicals, were impressive to witness, but the apparatus which made them possible was crude from an engineering standpoint; for example, a tri-color filter disc about two feet in diameter was revolved between the viewer and the screen of a cathode ray tube by means of a synchronous motor. The old days of the Nipkow disc were almost revived!

But now patents are coming through which protect inventions for producing full-color television images electronically. In a single issue of the *Official Gazette* of the United States Patent Office, no less than three methods of producing this result are contemplated.

One of these, the invention of Everett Crosby, of New York City, has certain phases which prove extremely interesting. In his pick-up (which is the multicolor counterpart of the familiar Iconoscope), a tri-color screen is interposed between the object to be televised and the mosaic of the tube; this screen is within the same envelope as houses the elements of the tube. Basically, the effect is to pick up the portion of the image coming through Color A of the screen, then that coming through Color B, then through Color C, and through persistence of vision combining the three unit scans into a natural-color whole. Actually, the system is not quite so simple as that, for the tube is by no means an ordinary Iconoscope with a filter added. The idea is worth far more space than can be given to it here, and the interested reader is referred to Patent No. 2,296,908, a copy of which can be obtained from the United States Patent Office, Richmond, Va., upon payment of 10c in coin.

A German idea, taken over by the Alien Property Custodian, is considerably less practical, for it makes use of the two-color method which has been virtually abandoned here and in Eng-

land as unsatisfactory, even though it employs mechanical means. Its ingenuity, however, makes it of some interest for it gets away from the cumbersome disc system, employing instead a two-part vibrating reflector, used in conjunction with an ordinary television projection tube. Its basis is two reflecting surfaces, each of which incorporates a vibrating color filter (probably a red-orange and a blue-green, as in the pre-Technicolor movies, such as Kinemacolor), which are mounted at an obtuse angle. The image is received in black-and-white, projected through a lens system to the oscillating filter, and thence reflected through an optical system to the view-

ing screen, alternate complete images being in the different colors.

The pictures are, naturally, picked up through a similar system, alternate frames being used for each of the two colors. While the vibration of the reflectors can be controlled quite easily by the framing signals, the system is of no great value, for two-color work has been found incapable of providing natural color effects. In fact, Baird, who experimented with it some years ago, soon dropped it to progress to three colors. Even as far back as 1926, when color television was demonstrated here by the Bell Telephone Laboratories, three colors were set as the minimum standard. Nevertheless,

**IN ACTION!**

Whether in the sweating tropical jungles, blistering deserts—the words "In Action" have called for a monumental task of planning and preparation on the Home Front. Though it may not be as conspicuous as some others, we here at Regal Amplifier Mfg. Corp. are proud of the job that we are doing to make those words come to life. Ours is a task assigned because of the intimate knowledge of and our long experience in solving Sound and Intercommunications Problems under the most difficult conditions. "In Action"—is not new to us—in Peace or War—we are always ready to serve ably and well.

Manufacturers of the famous TokFone Line of Amplifiers and Amplifying Systems, Paging Systems, Electronic Air Raid Sirens, Intercommunication Systems and Sound Equipment for every need.

**Consultation without Obligation**

**REGAL AMPLIFIER MFG. CORP.**  
14-16 WEST 17th STREET • NEW YORK, N. Y.



## KEEP 'EM "POUNDING BRASS"

Put your finger on any important strategic point of today's worldwar map and you'll find one or more American radio operator on the job, "pounding brass" for Victory!

Yes—on the land, on and under the sea, in the air—everywhere radio equipment must be operated with speed, precision, and courage—you'll find Melville-trained men at work! Their outstanding performance is the reason why so many leading airlines of the world look to Melville for new men and women—why the Army, Navy, Marines, Merchant Marine and Coast Guard welcome the cooperation they are getting from Melville. The management of this School is proud of every Melville graduate who is now "doing his stuff" in the service of the United Nations and in Commercial radio aboard ships and planes of the world.

## MELVILLE

**AERONAUTICAL RADIO SCHOOL, INC.**  
45 West 45th Street New York City  
Training Men & Women for Radio in the Service of  
**AIRLINES - ARMY - NAVY - MARINES - MERCHANT  
MARINE - COAST GUARD - INDUSTRY**

## LEARN CODE the way you'll be using it

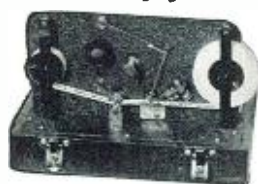

by SOUND

The best way to learn to read code is by listening to code. The best way to learn to send code is by hearing your own sending repeated back to you. With the new All-Electric Master Teleplex Code Teaching Machine, you learn code the natural, easy, fascinating way. Only instrument ever produced which records your sending in visible dots and dashes—then SENDS BACK your own key work at any speed you desire. There are NO PERFORATIONS—NO INK. Far superior to anything ever developed... a marvel of simplicity. That's why practically every school teaching code uses MASTER TELEPLEX. We furnish complete course, lend you All-Electric Master Teleplex, give you personal instruction with a MONEY-BACK GUARANTEE—all at a surprisingly low cost per month. Write today for FREE catalog RX-12. No obligation.

**TELEPLEX CO., 107 HUDSON ST.  
JERSEY CITY, N. J.**

**BE PATRIOTIC  
BUY U. S. WAR STAMPS  
AND BONDS**

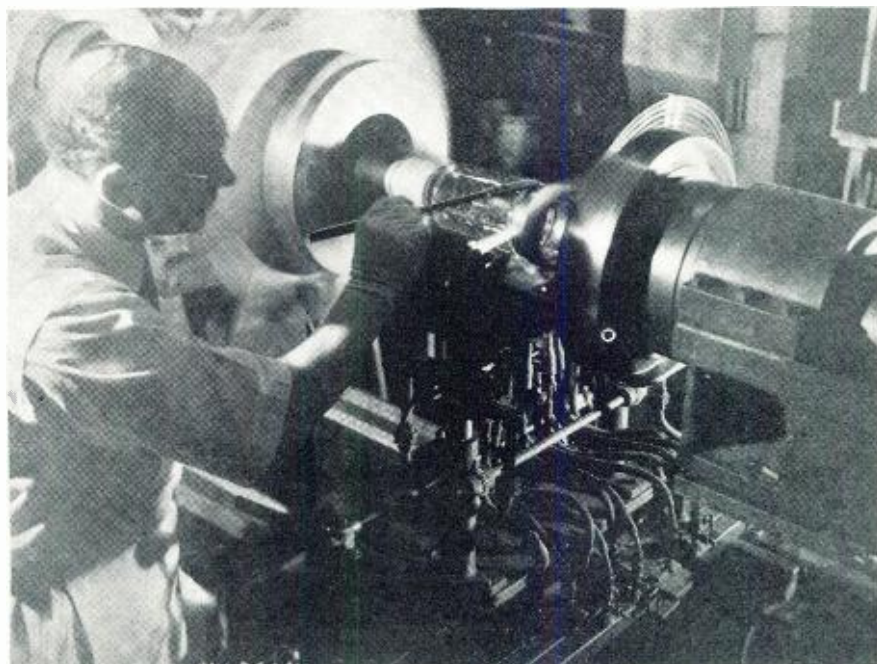

Adding finishing touches to a radio transmitting tube.

it is interesting to know what the enemy is doing.

But of far greater importance is the three color system which Earl I. Anderson, of New York City, has assigned to the Radio Corporation of America, although it uses the cumbersome color disc. Its features—or, at least, one of them—is that the motor which drives the disc is fed from the vertical deflection generator. This assures that the motor will keep perfect synchronism with the frame frequency of the picture. Also important is the fact that energy from this frequency generation circuit is applied to the accelerating grid of the television pick-up tube. This means that a deficiency of sensitivity to any portion of the spectrum can be compensated for by *synchronizing a voltage change on this grid with the color of the particular filter interposed between the tube and the lens at any instant.*

When employed in a receiving circuit, the vertical frame frequency will hold the color filter disc in "synch" in a manner not entirely unlike the way which was said to have been employed by CBS engineers in their color system. But the Anderson method will permit color manipulation if the bias on the accelerating grid is similarly controlled. Those who wish to study this system more fully may refer to Patent No. 2,297,524.

Although RCA is reluctant to talk of its post-war plans, this and other patents indicate that while it, like all other major companies, in the field, is bending every effort to help in attaining a speedy victory for the United Nations, it is giving thought to peacetime planning.

Among the other television patents which have been assigned to this company is one which covers a method of avoiding the burned spots which appear on the screen when the set is turned on while warm. By means of

a suitably designed voltage divider, with which a fixed condenser is employed, the voltage applied to the first accelerating anode is made relatively low when the receiver is first turned on, gradually becoming higher. Thus the intensity of the spot will be kept to a safely low level until the sweep circuits commence to function. The length of time which the voltage takes to build up to the desired maximum may be controlled by a choice of values for the voltage divider and the fixed capacitor. The patent, No. 2,297,547, was granted to Dudley E. Foster and John A. Rankin.

The cathode ray tube as a visual indicator in a direction finder, which might be used on airplanes or as a land goniometric device for airplane spotting, is another enemy device which our Alien Property Custodian has received. Briefly, it consists of three rotatable loop antennae, two receivers, and a cathode ray tube.

The outputs of two of the loops are connected to the twin primaries of a coupler, one pair of connections being reversed; the secondary of this coupling transformer is fed into a radio receiver, the output of which goes to the horizontal deflecting plates of a CR tube. The third loop, located between the other pair is coupled to a second receiver, and its output is fed through a phase-adjusting circuit to the vertical deflecting plates of the CR tube. The intensity of the signals, as altered by the rotation of the loops, will cause the cathode beam to be deflected to different portions of the screen on the tube, thus revealing the position of the source of the intercepted radio waves. The tube may be marked with compass bearings, or even a map of the territory being covered by the device. Patent No. 2,297,249, discloses the invention; it will be interesting to compare it with Patent No. 2,297,126, the invention of an



American, Alfred W. Barber, which also employs a cathode ray tube as a directional tuning indicator.

Several new methods of recording and reproducing sound have also been covered recently, and one is of especial interest since it makes use of an old principle in a new way. All readers of this magazine are doubtless familiar with systems in which a ribbon or wire made of magnetic metal is passed over the pole of an electro-magnet which is energized at audio frequencies, the impulses causing the ribbon or wire to be magnetized accordingly, and play-back being accomplished by running the wire or ribbon between the poles of a device much like a magnetic pick-up.

The converse is covered in Patent 2,297,398, which describes a similar system employing *electrostatics* rather than *electro-magnetism*. In this invention, the ribbon is made of an insulating material, and passes over a drum inside which a high positive potential is maintained. The negative end of this circuit is connected to a coil within the mounting of a stylus bearing upon the ribbon, and an audio frequency current is passed through a coil within this mounting. In this way, an electro-static charge is impressed upon the ribbon. The patent claims that the molecules of the ribbon "hold the load (*charge—Ed.*) insulated from each other," which is scarcely grammar. Pick-up would be obtained by causing the charged areas of the ribbon to discharge through any suitable static electricity detector.

There are many more developments than can be described here, but this will give you some idea of the month's progress in electronics. Next month there will be a description of a new frequency modulation system, rights to which have just been acquired by a leading manufacturer, and several other important disclosures—including, *What the Enemy Is Doing*.

-50-

### Industrial Sound

(Continued from page 43)

This amplifier is equipped with the 24 volt relay discussed above to control the plate supply, and it drives three booster amplifiers, each of which is equipped with a similar relay and each of which provides an output of 100 watts of audio power.

The relay panel is located beneath the driver amplifier and the five speaker relays and master stand-by relay are shown.

Provision has been made for connecting a portable phonograph unit to play music and recorded messages to the workers. These records are frequently supplied by the Army and Navy and consist of "pep talks" for the workers, advising them of the use their equipment is put to, and of the importance of the job they are doing. Frequently too, the War Department sends a representative to the plant to talk directly to the workers and the



The bomber must be built and the crew must be trained.

In war plants and in training stations throughout America, **BOGEN CENTRALIZED SOUND SYSTEMS** are helping to build the ships and train the men—expediting production, locating vital men instantly, issuing orders and automatic signals and alarms.

May we tell you how?

**DAVID BOGEN CO., INC.**  
663 BROADWAY,  
NEW YORK CITY



## MORE THAN 11 "HASH MARKS"

... and we have earned them the hard way too! majoring in electrical research thruout our 47 years. . . . Thordarson Engineers have always been ahead of new developments . . . that is why you will find, both in military and civilian use, engineers specifying Thordarson transformers for that vital job where unflinching performance is paramount.

Submit your transformer problems to Thordarson Engineers . . . they know how to solve them.

## THORDARSON

ELECTRIC MFG. CO.  
500 WEST HURON ST., CHICAGO, ILLINOIS  
*Transformer Specialists Since 1895*



### NEW CATALOG

#### OF SOUND AMPLIFYING SYSTEMS

AUDIOGRAPH Sound Systems represent the latest in Public Address equipment—a complete line plus pre-tested accessories.

#### NEW LOWER PRICES

Outstanding quality and performance at prices that help you meet any competition.

WRITE FOR YOUR FREE COPY

## AUDIOGRAPH

THE FIRST NAME IN SOUND

John Meck Industries—Liberty of Pennsylvania Ave., Plymouth, Ind.

## RADIO ENGINEERING

DEGREE IN 2 1/2 YEARS

• Complete Radio Engineering Course in 27 months. Bachelor of Science Degree. Radio (television, talking pictures and the vast electronic field) offers unusual opportunities. War needs call for the engineer. Demand exceeds the supply. Courses also in Civil, Electrical, Mechanical, Chemical, Aeronautical Engineering; Business Administration, Accounting, Secretarial Science. Tuition, living costs, low. World famous for technical 2 1/2 year courses. Special preparatory department for those who lack required high school work. Enter January, March, June, September. 59th year. Write for catalog, 1612-2 COLLEGE AVE. ANGOLA, IND.



## TRI-STATE COLLEGE

# LET'S ALL HELP WIN THIS WAR!

You can help win this war by contacting us if you are willing to convert your equipment into cash.

After the war, you can buy new and better apparatus with what we will pay you now.

Write, telephone or telegraph us description of communications receivers, transmitters and parts, you will be paid cash immediately without bother or red tape.

We also have a store at 2335 Westwood Blvd., West Los Angeles, Calif.

## COMPLETE STOCKS

★ We still have large stocks of receivers, 2½ meter equipment, meters, tubes, transformers, resistors, condensers, panels, chassis, and radio parts of all sorts. We sell and rent code teaching equipment. Your orders and inquiries invited.

## HENRY RADIO SHOP

BUTLER, MISSOURI

"World's Largest Distributor of Communications Receivers"

★ ★ ★ ★ ★ ★ ★ ★ ★ ★ ★ ★ ★ ★ ★ ★

## MODERNIZE Old Radios

MUTUAL offers exclusive quality merchandise for *Immediate Delivery*. Large assortment 1942 component radio parts. Complete line of uncut cabinets, and chassis, speakers, record-changers, and home-recording units will help Servicemen to carry on. Tremendous demand for replacement units. Be prepared to serve your customers. We are prepared to serve you!

WRITE TODAY FOR COMPLETE CIRCULAR

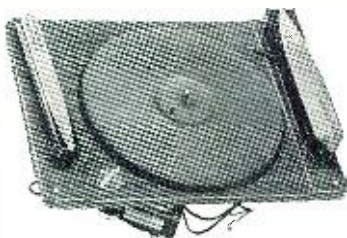

GENERAL INDUSTRIES dual speed recorder. Operates at 78 or 33½ R.P.M. Crystal pick-up, magnetic cutting arm. Sturdy construction, heavy duty motor. De Luxe Model 240. **\$24.95**  
Net .....

**MUTUAL RADIO PRODUCTS CO.**

1579 Milwaukee Avenue  
Chicago, Illinois

tremendous boost in morale achieved through this procedure is manifested in greatly increased production.

In operating the system, the controls at the main rack are pre-set, and unless it is desired to distribute recorded programs, it is completely unnecessary for anyone to go to the rack at all, once the a.c. switch has been turned on. This switch can be seen on the second panel of the front view of the rack and this view also shows the indicating pilot lights on each booster amplifier. The pilot lights on the left are green and are lit when the filaments of the tubes in the boosters are lit. The pilot lights on the right are red and light when voltage is supplied to the plates of the tubes.

As noted earlier in the article, the plant in which the above described system is installed, consists of three connected buildings. Building No. 1 has a basement and two floors, each approximately 150 feet long by 225 feet wide. Building No. 2 has three floors, each approximately 97 feet long by 212 feet wide. Building No. 3 has a basement and three floors, each approximately 91 feet long by 218 feet wide. A loading platform feeds into the basement of Building No. 3, and another loading platform feeds onto the first floor of Building No. 1.

Each floor in Building No. 1 is identical in area covered and in noise level—and it was determined that three Bogen-University RCR projectors, when driven with 10 watts of power each, would distribute sound over the whole area at a level 3 db above what was normally obtained. The RCR is a radial type trumpet of reflex design which is extremely efficient and which because of its very well protected driver unit and spun metal construction proves ideal for factory use. The projectors were hung from the ceiling and located along the center of the floor running down the longest side. The two end projectors were mounted fifty feet off the wall and the center projector was separated 60 feet from each of the other two since the others supported it in covering the floor area. An eight inch cone speaker in a metal housing was used to cover the loading platform in Building No. 1, and was driven with two watts of power. A boiler room located in the basement of this building was equipped in the same way.

Building No. 1, therefore, required a total of 94 watts.

Floor No. 1 of Building No. 2, though smaller in area than any of the floors in Building No. 1 had a higher noise level and it was determined that a layout of RCR projectors similar to that employed in Building No. 1, and using the same amount of power would be necessary (10 watts in each radial projector). Floor No. 2 was equipped with two CR trumpets mounted at each end of the floor. The CR is similar to the RCR with the exception that it is a projector type and not a radial type. Five watts was determined as requisite for each Model CR. The third floor is much the same

as the second with the exception that approximately one seventh of the floor is partitioned and has an extremely high noise level. As a result, three CR projectors were employed, each being fed with five watts of power.

The total power required by Building No. 2 was 55 watts.

The basement of Building No. 3 required six Bogen University IB8 projectors each driven by five watts and an additional IB8 driven by three watts was used at the loading platform. The IB8 is a smaller model of the Model CR, somewhat less efficient and with a lower power handling capacity.

Floor No. 1 required 2 Model RCR and 2 Model CR each driven by ten watts. The second floor of Building No. 3 contains the offices and three 8" permanent magnet speakers, mounted in walnut baffles and driven with one watt each were used. In addition, three Model CR projectors, each fed with 5 watts, were employed to cover the working areas.

The third floor used a total of five CR projectors, three of which were driven with five watts and two with ten watts each, because of the considerably higher noise level area they were required to cover.

A total of 125 watts of audio power was required to cover Building No. 3 and a combined total of 274 watts was, therefore, necessary to cover the complete plant. Provision was made to make a total of 300 watts available so that expansion of the system could be accomplished without the necessity for changing the rack, although the rack can accommodate another 100 watt booster amplifier (see rear view). The reserve power also made it unnecessary at any time to drive the amplifiers to maximum output.

The watchman's control station was located on the first floor of Building No. 2 and the telephone operator's control station was located in the office on the second floor of Building No. 3.

Each of the four speaker loops was wired with a No. 14 rubber and braid covered, stranded twisted pair.

This system has been in operation six full days and nights a week for over six months. It has helped to speed production, to raise workers' morale and to get things done quickly.

-30-

**Did You Get Your Copy  
of the November Signal**

**Corps Issue?**

**Better Hurry!**

## Audio Frequencies

(Continued from page 19)

may be employed only where the amount of power it draws from the frequency source is of little or no consequence. Power consumption of the instrument shown in the photograph is 2.5 volt-amperes.

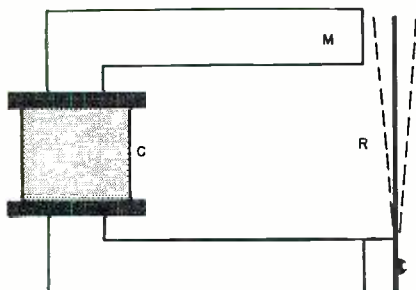

Fig. 10.

### Vibrating-Reed-Type Frequency Meter

The principle of the vibrating reed as a frequency indicator is illustrated by Figure 10. In this arrangement, M is a permanent magnet, on the yoke of which is mounted a coil, C, consisting of many turns of fine wire. The coil is connected to the source of alternating voltage of unknown frequency.

The reed, R, is a thin strip of magnetic metal, such as iron or steel, fastened at its lower end to one pole of the magnet and with its upper end resting a short distance from the other magnetic pole. This springy reed has a natural period of vibration which is determined chiefly by its length and thickness, it being a well-known fact that if such a reed is plucked, it will give forth a musical sound of fairly constant pitch (frequency).

When an alternating current is caused to flow through the magnet coil, the field strength of the magnetic circuit increases and decreases in unison with the unknown applied frequency, causing the reed to be set into vibration. This vibration will be most intense when the natural frequency of the reed and that of the alternating current are one and the same. In fact, the reed vibrates so vigorously under these conditions that it becomes invisible to the eye. Several cycles above and below the resonant frequency, the reed will vibrate (due to the relatively poor electro-mechanical selectivity),

but the amplitude will be so slight as to be imperceptible or very nearly so.

There are numerous variations in application of the reed principle. For example, the arrangement shown in Figure 12 might be employed. Here the reed is attached to one pole of an electromagnet which is energized by the frequency source through the field coil. In this respect, the magnet is similar to the field unit of dynamic speaker. The free end of the reed stands at rest close to the pole of a permanent magnet. As alternating current flows through the field coil, the reed becomes alternately north and south in magnetic polarity and, since it is in magnetic relation to a single pole of the permanent magnet, it will be alternately attracted and repelled by the latter, giving rise to vibration. Again, the amplitude of vibration will be greatest at the natural frequency of the reed.

In still another arrangement, the reed is fastened to a metallic yoke, and vibration arising from a magnetic "motor" is conveyed to the reed.

If several reeds, cut to various lengths, are arranged side by side along a wide magnet pole, as in Figure 13, we have a device which is capable of indicating as many frequencies as we have reeds. This would be a simple vibrating-reed-type audio frequency meter. If the reed lengths do not differ by very much, several reeds would naturally vibrate for each incoming frequency, but the one whose natural period of vibration corresponds to that of the impressed voltage will have the greatest amplitude of vibration and may readily be identified. Generally, this one reed will disappear from sight because of its rapid movement while immediately adjacent ones will be observed to vibrate less intensely. The reeds may be tuned very accurately by precisely trimming their length, either by cutting or mounting, or by final "finishing" of their thicknesses.

It is entirely practicable to mount a scale on the device shown in Figure 13, marking the spaces below the reeds in the number of cycles per second to which they correspond.

Figures 1 and 2 show portable and panel models respectively of a commercially-built reed-type frequency meter. Meters of this type are supplied to cover frequencies between 10 and 500 cycles per second in single or double ranges. They normally con-

(Continued on page 77)

Fig. 11.

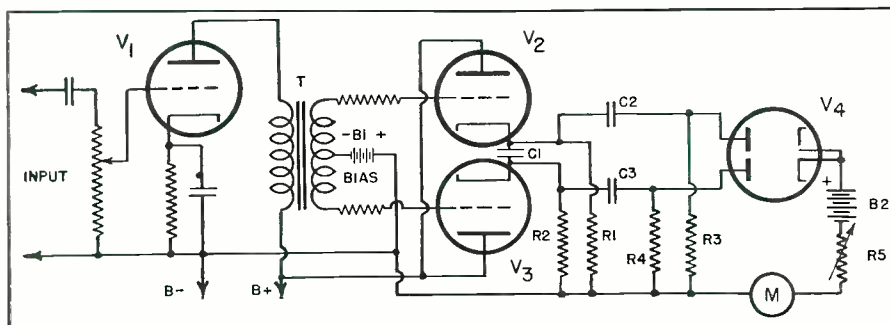

# E E C R I C Y

Learn AT HOME to Earn MORE MONEY

3 Big Volumes Hundreds of Illustrations



AMAZING 3 VOLUME ELECTRICAL ENCYCLOPEDIA FREE 7 DAY TRIAL

Now it's EASY, PRACTICAL to learn Electricity at home. New COYNE Reference Set helps you prepare for good-pay job in war work or Service. No lessons or tests. Study as convenient. Use books on the job when you're trained.

Big 8 1/2 x 11 inch Pages. Hundreds of pictures and diagrams. Hundreds of subjects. Red, gold binding

### FREE WITH ENCYCLOPEDIA

One year of personal technical advice from our staff of instructors. These books are used by hundreds of Electricians on the job. Hundreds of subjects clearly indexed and easy to locate.

Covers everything Electrical: Armatures, A.C. & D.C. motors, electricity, refrigeration, etc. Answers electrical questions quickly. Includes Radio, Television.

SEE THEM RISK FREE You don't have to risk a penny. To get your set promptly, just mail coupon. Examine books 7 days risk free. Mail coupon now. LIMITED OFFER.

H. C. LEWIS, Pres., COYNE ELECTRICAL SCHOOL

500 South Paulina Street, Dept. 92-71, Chicago, Ill. Send me the big Coyne Electrical Reference and Instruction Encyclopedia. Within 7 days after receiving the books, I'll either return them or send You \$3, and \$3 a month until advertised price of \$12.00 is paid. We pay the shipping charges.

NAME \_\_\_\_\_  
 ADDRESS \_\_\_\_\_  
 CITY \_\_\_\_\_ STATE \_\_\_\_\_  
 OCCUPATION \_\_\_\_\_ AGE \_\_\_\_\_  
**SAVE 10%.** Send cash price, \$10.80, with order if preferred—you save \$1.20. Same 7-day free trial and return privilege.

# Letters to the Editor

on the Special U. S. Army Signal Corps  
Issue of Radio News

AT this writing—just a few days after the Special November Signal Corps Issue appeared on the newsstands—it looks like a “sellout.” Letters are coming in by the hundreds from every part of the United States complimenting us on the undertaking. It is most gratifying to receive the reactions from those who have so kindly written. We have felt that such an issue was needed by the communications branch of our Army in order to present its complete story to the public—particularly to those taking an active part in our war effort from the radio viewpoint. The tremendous response substantiates our own beliefs and proves that we have been able to contribute something of value to our men whose duty it is to “get the message through.” The following excerpts are taken from some of the many letters received:

“This issue represents considerable work and certainly is an authoritative story of the U. S. Army Signal Corps. You deserve much credit for this, and we consider it a privilege to take the small part that we have in contributing to its success.”

WARREN HASEMEIER  
Vice President  
Wilcox-Gay Corporation

“May I take this opportunity to congratulate you and your staff on one of the finest issues of a magazine in the radio field that I have seen in many years. This is my idea of what a radio magazine should be like, both in the editorial and advertising content.”

“I am happy to have had a part in this achievement.”

IRWIN WAYBURN  
Hart Lehman, Advertising

“... It has already made the rounds of the office here, and everyone is very complimentary about it.”

“It is a grand editorial job... It must be a nice sensation to turn out material like this current issue.”

R. C. KASH, Editor  
Display World

“It is indeed a splendid history of the Army Signal Corps and an excellent picture of the present status and functions of the Army Signal Corps, which is a very vital part of our military system.”

I think you have performed a very useful and valuable work in publishing this issue.”

MELVIN J. MAAS, Rep.  
Congress of the United States

“I find it a very delightful and authentic re-cap of many Signal Corps activities, past and present. It is a book that I shall treasure and keep as a valuable part of my military library.”

EDGAR L. CLEWELL  
Brig. Gen. U. S. Army

“You certainly put out an ambitious issue. You are to be congratulated on the great detail in which you covered Army Signal Corps activities.”

E. L. DEGENER  
National Radio Institute

“I was very much pleased to receive the special United States Army Signal Corps issue of RADIO NEWS and read it with much interest.”

“As you say, one of the most potent elements in modern war, and without which any campaign must fail, is the communications systems, dominated by radio. This issue gives a very graphic account of the United States Army Signal Corps and its long record of achievement. I wish to compliment you on the attractive manner in which this story is presented.”

ARTHUR CAPPER  
United States Senate (Kansas)

“I have enjoyed reading this publication and wish to compliment your staff upon the condensation of this interesting and vital material.”

GEORGE H. BENDER  
Congressman-at-Large (Ohio)

“... I think this publication is one of the most interesting and highly informative that I have ever seen, and I have enjoyed reading it immensely. The photography in this issue is splendid as well as the material used and the manner in which it is presented. I know that the issue will be invaluable to me as a reference book.”

JOE STARNES  
Congress of the United States  
(Alabama)

“It is without doubt one of the finest publications of its kind I have ever seen, and you may be assured that it will be retained by me for years to come, both as a reference work and a valuable chronicle of that branch of our armed forces.”

A. A. FARMET, President  
Par-Metal Products Corp.

“I believe it a very valuable and interesting publication and agree with you that it will serve a useful and most important purpose in familiarizing citizens with the operations of that branch of the military services.”

SHERIDAN DOWNEY...  
United States Senate  
(California)

“From an examination of the book it appears to be an accurate, complete history of the organization and functions of the Signal Corps, compiled in a very able manner...”

F. O. CARROLL  
Colonel, Air Corps

“You are to be congratulated on the valuable information which you have included in this issue. The pictures are particularly noteworthy.”

LOUIS C. RABAUT  
Congress of the United States  
(Michigan)

“... I have pored through its pages with much interest. It is a splendid edition, leaving one impressed with the importance of the Signal Corps.”

R. R. WAESCHE  
Vice Admiral, U. S. Coast Guard

“... It is indeed a welcome addition to my personal library, containing, as it does, such a thorough and complete history of the Army Signal Corps. I consider it excellent in every respect.”

WOLCOTT P. HAYES  
Colonel, Air Corps  
Commanding

“Thank you for your letter of 22 October, 1942, in which you state that you are sending me a bound copy of the Signal Corps issue of RADIO NEWS. I shall be delighted to have this especially since I was, so to speak, more or less in at the birth of this splendid conception which you have so ably carried through to successful completion. I have already seen the issue and congratulate you on a beautiful job well done.”

I think that you and your associates may well feel you have made an important contribution to the war effort. We of the Signal Corps are very proud indeed of the record you have spread out in RADIO NEWS...”

C. O. BICKELHAUPT  
Colonel, Signal Corps.

“I want to compliment you on your U. S. Army Signal Corps issue for November, 1942. This is, indeed, a step forward in publishing and you may be sure that we're mighty proud to be included among the advertisers...”

VICTOR A. IRVINE  
Galvin Mfg. Corporation

-30-

## For The Record

(Continued from page 4)

Photographic Laboratory at the U. S. Army War College. Many of the photographs appearing in November as well as in other issues of RADIO NEWS are here developed and printed. Every possible step is taken to insure the finest photography, and those of you who have so kindly commented on the Salon and Color Sections of the November issue agree with us that they do outstanding work.

To each and every one of those who devoted their time and skill to the production of the November issue, we offer our sincere thanks. Rest assured, that RADIO NEWS will continue in its policy to offer whatever facilities are at our disposal in bringing to the radio-minded personnel of this nation factual data which will help to further our war effort, and to point out the importance of radio in all of its various branches.

### What of the WERS?

THERE seems to be little, if any, activity now going on by the amateur operators who have volunteered for WERS emergency communications work. During the recent flood difficulties in certain parts of the country, particularly in the east, there was a golden opportunity for this branch to function, but so far we have had no news of any activity. May we hope that steps will be taken to encourage the amateur by giving him an opportunity to serve when and if needed.

### NAB and RMA Get Together

IT NOW seems that something will be done for the radio serviceman now that the members of the NAB and RMA have arrived at certain decisions. It appears now that servicemen will be granted parts and in many cases these men will be deferred as being essential to the maintenance of public morale. We hope this will become a reality!

### More Test Equipment

THERE is still urgent need for all types of radio test equipment, whether they be oscilloscopes or inexpensive voltmeters. Manufacturers of these items cannot possibly keep up with the military demands, and those who are able to spare such items are requested to contact the Signal Corps office in their local service command. Another thought... dig out those meters and make a list of those you can spare. Fair prices are paid for these and there is no reason for hanging on to surplus instruments, as they will be most plentiful after the duration.

### Contents of This Issue

THERE is no technical subject in RADIO today more important than those dealing with electronic theory and application. So much progress has

(Continued on page 79)

(Continued from page 75)

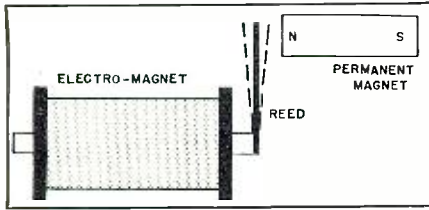

Fig. 12.

sume approximately 2 watts in operation, although they may be supplied for as low as 0.75-watt operation. The instruments are supplied for operating potentials between 5 v. and 660 v. The reeds are tuned by the manufacturer within 0.3% of the scale values, and response of the instrument is independent of waveform. A particular feature of the reed-type meter is the fact that it responds equally well to a.c. or pulsating d.c. and is not affected by external magnetic fields.

#### Electronic Frequency Meter

The electronic frequency meter makes it possible to read the value of an unknown frequency directly in cycles per second on the dial scale of a regular d'Arsonval meter, at the same time offering certain advantages not afforded by the simpler, direct-reading frequency meters.

Like the latter types, the electronic instrument shows the frequency value immediately upon connection of the instrument to the frequency source—there are no adjustments to perform—and in addition it permits the measurement of frequencies between 1 and 5,000 cycles per second in continuous ranges; presents a very high impedance to the frequency source, thereby requiring little power from the source; its operation is independent of the amplitude of the signal voltage over wide practical limits; and its operation is likewise independent of the signal voltage over comparable limits.

A standard manufactured electronic audio-frequency meter is shown in Figure 5 and the basic circuit of the instrument in Figure 11. Operation of this instrument is based upon the fact that equipotential pulses flowing in a circuit containing a d.c. milliammeter or microammeter will produce a meter deflection proportional to the number of pulses passing through the meter in each second. It is essential for this mode of operation that all of the pulses be of the same voltage. Under

Fig. 13.

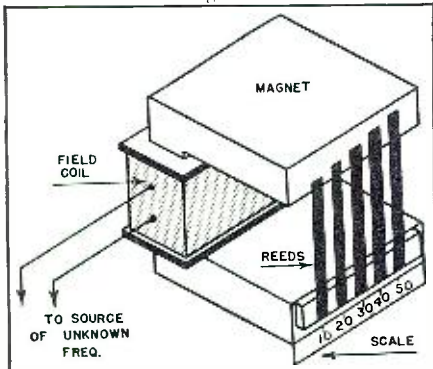

these conditions, the meter scale may be graduated directly in frequency.

The circuit (see Figure 11) employs an ingenious scheme for obtaining equipotential pulses from a voltage of unknown frequency. The mechanism of operation is based upon the maintenance of a constant voltage drop across a gaseous triode, once the tube has fired. The gaseous-triode grid is excited with the voltage of unknown frequency, and the circuit is so arranged that one such tube will extinguish the discharge in the other at the proper part of the signal-voltage cycle in order to produce constant-voltage d.c. pulses at the rate of the incoming frequency.

The signal voltage is applied to the input terminals of the amplifier, VI. The output transformer of this stage feeds the grids of two gaseous triodes,  $V_2$  and  $V_3$ , in push pull. The indicating instrument is a d.c. microammeter, M, connected in the cathode circuit of a double diode,  $V_4$ , together with a multiplier resistor,  $R_5$ , and the small battery,  $B_5$ , which together regulate the magnitude of current flowing through the meter.

Both plates of the diode are raised momentarily to a positive potential by the circuit embracing  $V_2$ ,  $V_3$ ,  $C_1$ ,  $R_1$ ,  $R_2$ ,  $R_3$ ,  $R_4$ ,  $C_2$ , and  $C_3$ , each time the polarity of the input signal voltage reverses, and a single pulse is delivered to the meter, M. The direct plate voltage applied to  $V_2$  and  $V_3$  must be regulated.

The setting of  $R_5$  determines at which point on the meter scale a given frequency will be indicated. Thus, if M is a 0-500 d.c. microammeter,  $R_5$  may be adjusted to bring the pointer to 500 microamperes when the signal voltage is 500 cycles per second. Response of the circuit is linear up to 5,000 cycles per second; hence a standard microammeter may be employed and only one point on the scale need be calibrated against a known audio frequency. All other points will be in calibration. Thus, if the meter circuit has been set to bring the pointer to 500 microamperes for signal frequency of 500 cycles, then a signal frequency of 380 cycles will drive the pointer to 380 microamperes.

The frequency range over which the instrument is capable of operating is determined by the values of  $C_1$ ,  $C_2$ ,  $C_3$ , and  $R_5$ . Each of these components are switched to new values when the frequency range is changed.

The frequency range provided by the instrument shown in Figure 5 is 0-5000 cycles per second in five ranges: 0-200, 0-500, 0-1000, 0-2000, and 0-5000 c.p.s. The accuracy corresponds to that of the indicating meter, 2% of full scale—or better. The signal amplitude may swing from 2 to 200 volts without causing a change in the indicated frequency. Input impedance of the instrument is approximately 1 megohm.

The electronic frequency meter may be employed in all audio-frequency measurements where rapid, direct fre-

## 7 DAYS Free Examination

# PRACTICAL RADIO INFORMATION

Including Frequency Modulation—Television, etc.



Inside Radio Information for all Servicemen—Aircraft Pilots, Students. AUDELS RADIO RADIOMANS GUIDE contains 772 Pages, 400 Diagrams & Photos is complete—gives Authentic Principles & Practices in Construction, Operation, Service & Repairs. Covers clearly and concisely Radio fundamentals—Ohm's Law—Physics of sound as related to radio science—Measuring instruments—Power supply—Resistors—Inductors—Condensers—Transformers and examples—Broadcasting stations—Radio Telephony—Receivers—Diagrams—Construction—Control systems—Loud speakers—Antenna systems—Auto Radio—Phonograph pickups—Public Address Systems—Aircraft & Marine Radio—Radio Compass—Beacons—Automatic Radio Alarms—Short Wave—Coil Calculations—Testing—Cathode ray oscillographs—Static Elimination—Trouble Pointers—Underwriter's standards—Units and tables—Frequency Modulation—REVIEW QUESTIONS & ANSWERS. Ready Reference Index.

**\$4 COMPLETE • PAY ONLY \$1 A MO.**  
Get this practical information in handy form for yourself—Fill in and MAIL COUPON TODAY

AUDELS, Publishers, 49 W. 23rd St., N.Y.  
Mail AUDELS NEW RADIO RADIOMANS GUIDE for free examination. If O. K., I will send you \$4 in 3 days; then remit \$1 monthly until \$4 is paid. Otherwise I will return it.

Name \_\_\_\_\_  
Address \_\_\_\_\_  
Occupation \_\_\_\_\_  
Reference \_\_\_\_\_ RN

## TEST with



### SECONDARY FREQUENCY STANDARD

Used by U. S. Army Signal Corps

- ★ Exact Frequency Measurement 100 to 60,000 K.C.
- ★ Checks Laboratory Signal Generator Accuracy.
- ★ Checks Factory Test Oscillator Accuracy.
- ★ Checks Receiver and Transmitter Calibration. Unexcelled for setting Electron-coupled Oscillator Transmitter Frequency to Close Tolerance, thereby eliminating Spot Frequency Crystals.
- ★ Signal at Every 1000 K.C. provides Rapid Location of 100 and 10 K.C. Beats.
- ★ Ideal for Portable Use. Weight 12 lbs. Size 5" x 8" x 8 1/2".

Operates on 115, 130, 150, 220, and 250 volt 25 to 60 cycle A.C. Supplied complete with Biley 100 and 1000 K.C. duo-frequency crystal and one 6V6 oscillator, one 6N7 harmonic generator, one 6L7 harmonic amplifier and one 6X5 rectifier. (Price Complete \$39.50)

Write for details

**FRED E. GARNER CO.**

Radio and Marine Equipment

43 E. Ohio St. Chicago, Ill.



## EL Menco MICA CONDENSERS

Always dependable in the past, today have no difficulty in meeting the rigid requirements demanded by our armed forces.

### MICA CONDENSERS—AIR TRIMMERS

### MICA TRIMMERS

THE ELECTRO-MOTIVE MANFG. CO.

WILLIMANTIC

CONNECTICUT

## NOW—A REALLY HIGH-POWERED— Radio Engineering Library



### NOTE:

The Library comprises a selection of books culled from leading McGraw-Hill publications in the radio field.

- especially selected by radio specialists of McGraw-Hill publications
- to give most complete, dependable coverage of facts needed by all whose fields are grounded on radio fundamentals
- available at a special price and terms

THESE books cover circuit phenomena, tube theory, networks, measurements, and other subjects—give specialized treatments of all fields of practical design and application. They are books of recognized position in the literature—books you will refer to and be referred to often. If you are a practical designer, researcher or engineer in any field based on radio, you want these books for the help they give in hundreds of problems throughout the whole field of radio engineering.

**5 VOLUMES, 3319 PAGES, 2289 ILLUSTRATIONS**

1. Eastman's FUNDAMENTALS OF VACUUM TUBES
  2. Terman's RADIO ENGINEERING
  3. Everitt's COMMUNICATION ENGINEERING
  4. Hund's HIGH FREQUENCY MEASUREMENTS
  5. Henney's RADIO ENGINEERING HANDBOOK
- 10 days' examination. Easy terms. Special price under this offer less than books bought separately. Add these standard works to your library now; pay small monthly installments, while you use the books.

**10 DAYS' FREE EXAMINATION—SEND COUPON**

McGraw-Hill Book Co., 330 W. 42nd Street, N. Y. C.

Send me Radio Engineering Library, 5 vols., for 10 days' examination on approval. In 10 days I will send \$3.00, plus few cents postage, and \$3.00 monthly till \$24.00 is paid, or return books postpaid. (We pay postage on orders accompanied by remittance of first installment.)

Name .....

Address .....

City and State .....

Position .....

Company ..... RN-12-42

## RADIO TECHNOLOGY



RCA Institute offers an intensive two-year course of high standard embracing all phases of Radio and Television. Practical training with modern equipment. Also shorter specialized courses in Commercial Radio Operating, Radio and Television Servicing, and Aviation Communications. For Free Catalog write Dept. RN-42.

**RCA INSTITUTES, Inc.**

A Radio Corporation of America Service  
75 Varick St., New York

ASK  
RADIO  
HEADQUARTERS!

For  
**IMMEDIATE DELIVERY** on radio, electronic and sound equipment parts from our COMPLETE STOCKS. Prompt attention to small or large orders. Try us for those hard-to-find parts; our fast emergency service will solve your buying problems.

**FREE Buyers Guide**—130-page catalog available now! Send for your copy today. Write Dept. 12E2.

**LAFAYETTE RADIO CORP.**

901 W. JACKSON BLVD. CHICAGO, ILL.  
265 PEACHTREE ST., ATLANTA, GA.

★ Cameras and accessories at money-saving prices—ask for FREE PHOTOGRAPHIC Catalog

quency indications are required and only a negligible amount of power is to be drawn from the frequency source.

*Tuning Forks.* A precision fork may be employed in conjunction with a vacuum tube as a simple source of standard-frequency audio voltage.

Such forks are constructed of low-temperature-coefficient stainless steel, may be supplied at any specified frequency between 40 and 200 cycles per second, and have a negative frequency-temperature coefficient of better than 0.001% per degree Fahrenheit. Calibration is carried out with an accuracy of 0.005% at the specified frequency. The overall frequency stability of such forks under room temperature fluctuations might be expected to be within 0.01% and the frequency-voltage coefficient better than 0.005% per volt.

The performance of a precision tuning fork used as an audio standard of frequency may, of course, be improved still further by closely controlling the fork temperature by means of a special constant-temperature oven, and by regulating all circuit voltages and loading. The stability may thus be so improved that frequency variation would not exceed a very few parts per million per degree and per volt.

*Crystal Standards.* The most refined a.f. standard consists of a temperature-controlled, low-frequency quartz-crystal-controlled tube oscillator, followed by multivibrators operated at each of the desired standard audio frequencies and synchronized by the crystal oscillator. Suitable buffer amplifiers are inserted between all oscillator and multivibrator stages for purposes of isolation and resultant good stability.

Since the output-voltage waveform of a multivibrator is rich in harmonics, appropriate complex filter circuits are necessary to remove the harmonic voltage components from each standard-frequency fundamental.

*Government Standard-Frequency Signals.* The audio frequencies of 400 and 1,000 cycles per second employed to modulate the standard-frequency transmissions broadcast by the National Bureau of Standards radio station WWV are derived from an accurately-maintained crystal oscillator in the manner described above. These modulating frequencies have a very high order of accuracy.

*Power-Line Frequency.* Within the last decade, electric power companies have given increasing attention to maintenance of their power-line frequencies, and for some purposes these frequencies may be employed as audio standards. In some of our major cities, the public service companies are equipped to maintain the line frequency within a few tenths of a cycle.

Prior to employing the power-line frequency as a standard, the operator should call up his local power company in order to ascertain the exact frequency at the moment of test.

—30—

(Continued from page 76)

been made that it would be quite impossible to cover all subjects thoroughly within the scope of any one publication. Upon request of a good many of our readers, we have had several authoritative articles prepared and which appear in this issue. We have attempted to treat various subjects in such a manner that they may be understood by the average radio man, realizing the importance of simplifying the formulae in order that greatest possible value may be had from the contents. We urge you to read this material carefully, and you will realize what an important part electronics will play, not only in helping to win the war, but as a contributing factor after the war has been won.

**Douglas Fortune Killed in Plane Crash**

J. Douglas Fortune, Industrial Sales Engineer of Thordarson Electric Manufacturing Company was fatally injured while piloting a plane near Chicago on Saturday, October 17th. Mr.



"Doug" Fortune

Fortune was internationally known for his development work in radio and electronic equipment. During the last eight years he had been employed at the Thordarson Electric Manufacturing Company. Until 1939, as research and development engineer, he assisted in the creating and perfecting of many products. In 1939 he was promoted to the position of chief executive of the Industrial Sales Division in which capacity he became well known throughout the electronic industry for his engineering ability. In addition, Mr. Fortune had been a regular contributor to many leading radio publications and was the author of "Amateur Radio" a book widely read by Amateur Radio operators. Mr. Fortune's untimely death is a great loss to the radio industry which he so faithfully served.

**More for Your Money**

**T**HOSE of you who are regular subscribers to this publication have received a large bonus during the past year in the form of extra features and in the total number of pages of editorial material presented. In keeping with our desire to expand, you will find that this issue contains many more than the usual number of pages.

The coming year will no doubt be one of the most crucial periods in the glorious history of the United States. It will be interesting to observe the importance that radio will play. One thing is certain—there will be no shortage of informative material, and we will keep you informed as to latest developments, and are already planning on other special issues devoted to radio in the various branches of our military machine. We know that you radio men will continue to apply yourselves to serious study whenever you can find a bit of spare time—at least we hope so.

73 OR.....

**Electronic Tubes**

(Continued from page 16)

fraction of the power in the plate circuit to the grid circuit, providing the familiar oscillator circuit, which in this instance is one in which power higher than we ordinarily use is common.

We have been discussing the special purpose tubes that have been widely adopted in industrial electronic fields. There are, however, other special purpose tubes that have been developed for particular applications only. Take, for instance, the electronic vacuum camera recently announced. This camera photographs the crystalline structure of substances millionths of an inch thick. The device consists of a brass tube about three and one half feet long and a focusing magnet. A 40,000 volt electronic beam enters one end of the tube, is focused by means of the magnet upon the material suspended in the middle of the tube, diffracts, and produces a picture upon a lantern slide at the other end of the tube. The tube is evacuated to permit free passage of the electronic beam without collision with gas molecules. The material to be photographed is suspended in such a way that it can be raised or lowered or tilted at any angle to the beam.

Pictures require from one to ten seconds exposure, depending on the nature of the material.

The electronic beam is reflected by or transmitted through the material and a diffraction pattern or picture of the structure is produced upon the lantern slide. The spacing and intensity of the circles or spots of the pattern permits the viewer to determine the crystalline structure. Layers of atoms in table salt, for instance, are spaced only one-hundred millionth of an inch apart; yet an electronic picture of this spacing would show a circle one inch in diameter.

**RADIO PARTS  
SOUND SYSTEMS  
ELECTRONIC  
APPARATUS**

**★ Depend on  
RADOLEK ★**

**Send Now for the  
Big RADOLEK  
Buying Guide!**

Make Radolek your dependable source for essential radio, sound and electronic replacement parts—tubes, condensers, volume controls, resistors, transformers, etc.—all at low prices. Orders for industry, government services and war training programs are given special attention. Thousands rely on Radolek for their entire requirements. Send for the big Radolek Buying Guide NOW!

**FREE! Lowest Prices  
Fast Service**

Radolek quality, low prices and prompt service save valuable time and money. For complete satisfaction send your orders to Radolek.

**SEND TODAY! PASTE ON A POST CARD**

**RADOLEK CO., Dept. B-73  
601 W. Randolph St., Chicago, Ill.**

Please send the Big FREE Buying Guide

Name .....

Address .....

DEALER  SERVICEMAN  SOUND ENG.

**SAVE AT RADOLEK**

## DRAFTEES

★ ★ ★ ★ ★ **ATTENTION!** ★ ★ ★

It's up to you to secure a higher rank and better pay and you can do it in your own home with the Candler System. Over a quarter of a century experience in successfully teaching Radio Code. This easy, simplified method of learning Radio Code has trained thousands. There are courses for beginners and operators wishing maximum code proficiency. There is a big demand for Radio Code operators right now! . . . send a post card today for the

## FREE BOOK of FACTS

Tells you all about this fascinating work . . . your copy is waiting for you, there is no obligation . . . send for it today!



# CANDLER SYSTEM CO.

BOX 928  
DEPT. N-12, DENVER, COLORADO

★ ★ ★ ★ ★

## MODERN PARTS for MODERN CIRCUITS

THAT HAVE BEEN

*"Designed for Application"*

CATALOG UPON REQUEST

JAMES MILLEN MFG. CO. INC.  
150 EXCHANGE ST. MALDEN, MASS.

## GOOD JOBS in RADIO for young men age 17 to 20

As older men leave for the Army, RADIO calls for recent high school graduates. Prepare now for jobs in Radio Engineering; Broadcasting; Marine, Aviation, Police Radio; Servicing; Radio Manufacturing. Our streamlined courses give excellent preparation for Army and Navy Service. Expenses low. Write for free catalog.

THE DODGE TELEGRAPH & RADIO INSTITUTE  
409 Monroe St., Valparaiso, Indiana

**LES** Correspondence Courses in **RADIO and ELECTRICAL ENGINEERING**

**ELECTRICAL ENGINEERING** Get good electrical gold. Prepare yourself at Low Cost, for secure future. Modern course. So simplified anyone can understand quickly.

**RADIO ENGINEERING** Extra fine course in radio, public address, photo-electric work. Trains you to be super-service man, real vacuum-tube technician. Experimental kits furnished. Diploma on completion.

Send postcard or letter for Free Copies of school catalogs, full details, all about deferred payment plan, etc. SEND TO:

**LOW \$25 AS Course**

**LINCOLN ENGINEERING SCHOOL**, Box 931-R48, LINCOLN, Nebr.

## COMMERCIAL RADIO INSTITUTE

A radio training center for over twenty years. Well equipped. Excellent faculty. Practical RESIDENT COURSES in Radio Telegraphy, Broadcast, Servicing, Industrial, Television, Aeronautical, Drafting, Mathematics and Studio Technique. Placement Bureau. Day and Evening Classes Now Forming. Catalog upon request.

Dept. C, 38 W. Biddle St., Baltimore, Md.

## RADIO ENGINEERING DEGREE in 27 MONTHS

Intensive, specialized course, including strong basis in mathematics and electrical engineering, advanced Radio Theory and Design. Modern laboratory. Low tuition. Self-help opportunities. Also 27-month courses in Aeronautical, Chemical, Civil, Electrical and Mechanical Engineering. Participation in Civilian Pilot Training Program. Enter December, March, June, September. Catalog.

### INDIANA TECHNICAL COLLEGE

7122 E. Washington Blvd., Fort Wayne, Ind.

The famous electron-microscope special tube design also affords the scientist an opportunity to see and study objects magnified up to hundreds of thousands of diameters, as against mere thousands heretofore possible with ordinary means.

An induction electron accelerator that will speed electrons to energies of a hundred million volts recently announced, is another example of the unusual among special purpose electronic projects. The new machine will contain a huge electromagnet weighing 125 tons. At the heart of the magnet between seventy-eight inch diameter poles, where the magnetic field will be most intense, will be a six-foot hollow glass doughnut, inside of which the electrons will be speeded in a vacuum. The cross sections of the doughnut will be elliptical, five-inches high and eight-inches across.

The wall will be about one-quarter inch thick. This doughnut is truly a merry-go-round for electrons. Starting from an electron gun, containing an electrically heated filament like that of a small electric lamp, they will be whirled around a quarter of a million times in one-two-hundred and fortieth of a second on each trip, receiving a four hundred volt push. Their total travel will be about eight hundred miles.

With this amazing device, making available x-rays of voltages up to a hundred million, it may be possible for the first time to provide examinations of steel castings in excess of the eight inch thickness now possible. There are innumerable other possibilities of this giant electron maker; possibilities that truly stagger the human imagination.

The use of radio-frequency control in association with measurement devices, to study the viscosity, dielectric constant, power factor, lubricating quality and other properties of oil and similar liquids, is another form of electronic control that is rapidly becoming an important link in industry. In this instance, typical radio type tubes are used in "typical" radio type circuits. Naturally, the constants and the circuits are special, but their mode of operation can be quickly traced by those familiar with the radio tube and its variety of circuit applications.

The expanded use of the radio tube and its electronic power has provided those in radio with a golden opportunity, an opportunity that will grow with the coming years. For with the increased knowledge of the control of electrons, will come improvements in radio and industry, that have been heretofore absent from all realms of thought.

-50-

## NEXT MONTH All-Purpose Tester

## What's New in Radio

(Continued from page 39)

rather than by use of the conventional hands and dial.

The numerals which indicate the hour and minute at any instant are white on a black background. They are 2" high and are clearly visible at a distance.

The entire clock case is 19 3/4" long x 14 1/2" high x 3 3/4" deep. It is made of well finished walnut and gumwood.

The "VICTORY" TELOMETER takes its name from the large "V," and when hung on the walls of production departments, offices, stores, schools, etc., it serves as a remarkable stimulant in addition to telling the time.

It is manufactured and distributed by R. M. Gottlieb Association, Inc., Allentown, Penna.

-50-

## Classified

Rate 15c per word. Minimum, 10 words

### CORRESPONDENCE COURSES

RADIO Communications courses qualifying for all Federal licenses. Home study and resident courses. American Radio Institute, 1123 Broadway, New York, N. Y.

USED Correspondence Courses and Educational Books sold or rented. Inexpensive. Money-back guarantee. Write for Free Catalog listing 4000 bargains.—(Courses Bought.)—Lee Mountain, Pisgah, Ala.

CORRESPONDENCE Courses and educational books, slightly used. Sold. Rented. Exchanged. All subjects. Satisfaction guaranteed. Cash paid for used courses. Complete details and bargain catalog free. Write Nelson Company, 500 Sherman, Dept. M-237, Chicago.

### INSTRUCTION

COMMERCIAL Radio Operator's Questions and Answers. \$1.00 Per Element. G. C. Waller, 6540 E. Washington Blvd., Tulsa, Oklahoma.

LEARN radio code the New, Practical, Easy way. Use KolorKards, a copyrighted Code Memorizing and Practice System. Complete—Only \$1.00. KolorKards, Dept. RB, Bluffton, Ohio.

RADIO Service men and experimenters send for our giant radio catalogue. Save dollars. United Radio Co. (1000M), Newark, N. J.

### PATENT ATTORNEYS

PATENTS secured. Two valuable booklets sent free. Write immediately. Victor J. Evans & Co., 612-P Merlin Bldg., Washington, D. C.

INVENTORS—Before disclosing your invention to any one send for Form "Evidence of Conception"; "Schedule of Government and Attorneys' Fees" and instructions. Sent free. Lancaster, Allwine & Rommel, 414 Bowen Building, Washington, D. C.

### RADIO ENGINEERING

RADIO Engineering, broadcasting, aviation and police radio, servicing, marine and Morse telegraphy taught thoroughly. All expenses low. Catalog free. Dodge Institute, Elm St., Valparaiso, Ind.

### RADIO EQUIPMENT

BEST CASH PRICES for Oscilloscopes, V.O.M.s., Vacuum-tube Voltmeters—RCA, Hickok, Supreme, Precision, or equivalent makes. 0-1 Milliammeters and 0-5, 0-10, 0-25 AC or DC Ammeters, 3-inch size. Also 913, 807, 1852 and 884, etc., power tubes which have been slightly used. Idle test units and meters are needed for the war effort. Help train thousands of radio personnel by selling your equipment now. Ship for liberal appraisals to Allied Radio Corp., Dept. 1-M-C, 833 W. Jackson, Chicago.

WANTED—Hickok RFO-5 Oscillograph; 210S V.O.M. 530P Tube Tester; also RCA 161 Signalyst. State condition and price. Box 144, Noble, Ohio.



## PHOTO CREDITS

Page Numbers	Credits
10, 11, 12, 13...	U. S. Army Signal Corps
15.....	Spokane Radio
16.....	Radio Corporation
17.....	James G. Biddle Co.
18.....	General Radio Co.
19.....	Weston Elect. Inst. Co.
20, 21, 72.....	Westinghouse
22, 25.....	Western Union
23, 25.....	U. S. Naval Observatory
24.....	Elgin
26, 27, 28.....	Piper Studio
31, 35, 36.....	D. R. Statile and Melville Radio School
40, 41.....	General Electric
42, 43.....	The David Bogen Co.
44, 50.....	Palmer
46.....	Westinghouse

## Index to Advertisers

COMPANY	PAGE No.
Aerovox Corp.	81
Allied Radio Corp.	60
Amperite Corp.	75
Andel, Publishers	77
Bliley Electric Co.	68
David Bogen Co.	73
Candler System Co.	80
Capital Radio Eng. Inst.	58
Centralab	68
Classified	80
Colen-Gruhn Co., Inc.	47
Commercial Radio Inst.	80
Coyne Electrical School	75
Dodge Institute	80
Electro-Motive Co.	78
Fred E. Garner Co.	77
Hallcrafters Co.	Back Cover
Hammamrud Mfg. Co., Inc.	59
Bob Henry	74
Indiana Technical College	80
Lafayette Radio Corp.	78
Lake Radio Sales Co.	64
Lincoln Eng. Schools	80
P. R. Mallory & Co., Inc.	Second Cover
McElroy Mfg. Corp.	49
McGraw-Hill Book Co.	78
John Meck, Industries	73
Meissner Mfg. Co.	69
Melville Aeronautical Radio School	72
James Millen Mfg. Co., Inc.	80
Mutual Radio Products Co.	74
National Company, Inc.	61
National Radio Institute	3
National Schools	57
National Union Radio Corp.	70
Ohmite Mfg. Co.	56
Polymet Condenser Co.	54
R. C. A. Institute, Inc.	78
Radio & Tech. Publ. Co.	5
Radio-Television Institute	68
Radolek Co.	79
Randolph Radio	62
Regal Amplifier Mfg. Corp.	71
John F. Rider Publ. Co.	63
Shure Brothers	53
Snyder, Inc.	79
Solar Mfg. Co.	68
Sprague Products Co.	67
Sprayberry Academy of Radio	82
Standard Transformer Corp.	52
Supreme Publications	55
Sylvania Electric Products Inc.	50
Teleplex Co.	72
Thordarson Electric Mfg. Co.	73
Triplet Electrical Instrument Co.	66
Tri-State College	73
United States Army	Third Cover
United Transformer Co.	65

## Book Review

(Continued from page 38)

electrical fundamentals from the point of view of communications—telegraphy, telephony and radio. Designed for beginning students, the treatment is elementary, yet at the same time maintains a high standard of technical accuracy and provides a sound foundation in the subject. Examples illustrating the electrical fundamentals are given throughout the text, and many of these are numerical solutions, typical problems, and circuits found in communication.

-30-

## Aviation Radio

(Continued from page 31)

retard rusting and other bad effects.

It has been said that pliers have done more damage to radio equipment than any other tool. The reason is, of course, obvious. There are so many types and sizes of pliers that experience seems to be the only guide to proper usage.

Pliers take various shapes but each pair has been designed for specific tasks. Predominant among the many pliers found on the market today and usually found in the aviation radio technician's tool kit and shop are the following: long nose pliers; diagonal pliers; combination; slip joint; side cutting; and chain nose pliers.

Long nose pliers are designed for holding small parts, wire, etc., while being soldered or fastened to terminal strips, etc. They are not designed for heavy gripping and should not be used for tightening nuts, forming heavy wire, or gripping large surfaces. They are handy as an "out of the way" tool, i.e., placing washers on bolts, forming small wire loops for terminal connection, etc.

Diagonal pliers are intended for cutting only and should not be used as a gripping tool. There is a size of diagonal pliers for various sizes of wire; and it should be remembered that the easiest way to ruin them is to attempt to cut something too heavy or too hard for the jaws.

Combination pliers are, just as the name implies. They are capable of cutting wire, holding operations, etc. This tool is often misused because too much is expected of it. It should never be made to take the place of a wrench; in fact no pliers should "replace" a wrench for tightening or loosening nuts.

Slip joint (commonly called gas-pliers), although fine for gripping are taboo for anything else. Their use is discouraged.

Lineman's pliers or side cutting pliers are about the same as the combination with the exception that the handles are not shaped like a screw driver or reamer.

(To be continued next month)



# VICTORY CONDENSERS

- There's still a correct Aerovox condenser to service most radio sets—regardless of growing shortages, curtailment of critical materials, banning of previous types.

Here, for instance, are three "Victory" types or satisfactory substitutes for types no longer available to you. They are (a) Type PBS cardboard-case dry electrolytics, single, dual and triple section, 25 to 600 v. D.C.W., with handy adjustable metal mounting flanges. (b) Type PRS-V "Dandees" or tubular dry electrolytics, single and dual section, 25 to 450 v. (c) Ever-popular Type —84 paper tubulars, 400 to 1600 v., extra-sealed for long service. These three "Victory" types can handle 90% of your usual service needs.

## ● Ask Our Jobber...

Ask him for your copy of the new "Victory" catalog which will help you in the present wartime situation. Or write us direct.



YOUR COUNTRY URGENTLY NEEDS TRAINED RADIO TECHNICIAN

'LL TRAIN YOU QUICKLY FOR  
**GOOD RADIO JOBS**  
... CIVILIAN OR MILITARY!

I GIVE YOU FULL RADIO EQUIPMENT  
to do Practice-Giving Experiments!



IF YOU REMAIN A  
CIVILIAN OR ENTER  
MILITARY SERVICE ...  
Radio Training Will  
Enhance Your Future!

• READ THESE LETTERS •

**"Grossed Between \$150 and \$200"**

"Since finishing your training I've started in the Radio repair business. I have about all the work I can take care of. I have grossed between \$150 and \$200 in the last few months in my spare time. I think your Course is 'tops'." W. Francis Waseka, Fountain City, Wisconsin.

**"Salary Has Increased"**

"Since I have finished your radio training I had to enlarge my laboratory with some new equipment, as I have all the radio repair that I can handle. My salary has increased to 50 to 75 dollars a week. I install transmitter equipment and public addressing systems. Money can not buy the training that I received through your academy. To all young men that are interested in radio training the Sprayberry Training is the only training. You can not go wrong for I am the one that knows. Asa Smith, Post Box 528, Ft. Leavenworth, Kansas.

You Learn Easily in Spare Time  
... at Home or at Camp!

The Sprayberry Course is specially designed for easy understanding. Many practical features are included to help you make fast progress. Beginners need have no fear of "getting lost." The course starts right at the beginning of Radio ... unfolds each step in a simplified, logical style. You quickly develop a thorough-going knowledge of Radio Set Repair and Installation Work, Mobile Radio (Auto-Tank), Signal Tracing, Aviation Radio, Electronics, Television, Frequency Modulation, etc.

Training Prepares You for a Business of Your Own ... or Good Radio Jobs at Excellent Pay

Right now ... more than ever before, Radio offers amazing opportunities for trained men. Curtailment of new Radio set production insures an ever-increasing volume of civilian Radio Service work ... to keep the nation's home Radio receivers in good working order. Sprayberry training will give you quick, easy access to a profitable business of your own. Or you can choose an interesting, well-paying Radio job in one of the nation's Radio factories at work on Radio and electrical equipment for planes, tanks, ships, etc. These and many more are the civilian opportunities open to you. Should you enter the armed forces, your Radio training will qualify you for a higher rating—better pay and interesting work. Bear in mind, too, if you enter the Service after you start your Sprayberry course you can easily continue your studies at camp as countless fellows are now doing.

No Previous Experience Needed

It makes no difference what your education has been. I can fit you quickly for a good-paying radio job. Your success is my full responsibility. I make it easy for you to grasp Radio principles and remember them. Moreover, your training need not interfere with your present work.

EASY TO START

You can get complete details about my course by writing for my new, valuable FREE CATALOG. Mail coupon. No obligation.



YOU GET A DUAL PURPOSE  
RADIO SET FOR EXPERI  
MENTS AND SET TESTING

(1) I supply you with Radio Part which you use to gain pre-experience in Repair Work. (2) Most important ... these same parts are used as a Modern Signal Generator and for Signal Tracing, etc., write for details.

EARN WHILE YOU LEARN

Along with your Training, you will receive my BUSINESS BUILDERS which will show you how to put your knowledge to profitable use in handling money-making Radio Service jobs shortly after you begin Training.

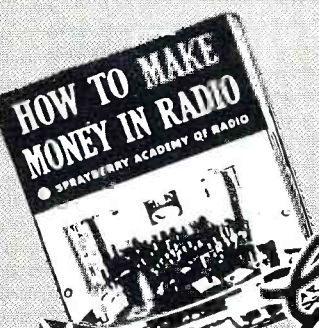

Get **FREE BOOK**

SPRAYBERRY ACADEMY OF RADIO  
F. L. Sprayberry, Pres.  
525-M University Place, N. W.  
Washington, D. C.  
Please send me FREE copy of "HOW TO MAKE MONEY IN RADIO".  
Name ..... Age .....  
Address .....  
City ..... State .....  
Tear off this coupon, mail in envelope or paste on penny postcard.



**REMEMBER** THE SPRAYBERRY COURSE IS SOLD UNDER MONEY-BACK AGREEMENT



**YOU'RE WAY AHEAD OF THE ACTION  
IN THE U.S. ARMY SIGNAL CORPS**

• Some day American voices will rock the Imperial Palace in Tokyo and cause the defenses of Berlin to tremble. They will be the voices of U. S. Army radio men, relaying commands for the final attack. Will yours be one of them?

**I**N THIS fast-moving war, words are weapons. Split-second communications are vital to the timing and teamwork that win battles. As one of Uncle Sam's radio soldiers, you not only see action—you help to guide and direct it!

In Army communications, your opportunities for heroic service are limitless. At the same time, you receive training and experience that will be invaluable for a successful after-the-war career. You learn how to assemble, install and operate the most modern radio transmitters, receivers, "Walkie-Talkies," "Electronic Sentries" and scores of other closely guarded secret devices—pioneers of future industries—which combine today to knit the whole Army into one hard-fighting unit.

Any man, physically fit, from 18 to 44, inclusive, may enlist. Licensed radio operators and radio, telegraph and telephone workers may enlist for active duty at once. They may advance rapidly up to \$138 a month, plus board, shelter and uniforms, as they earn higher technical ratings.

Men of 18 and 19 may choose enlistment in the Signal Corps without any previous training or experience.

Those without qualifying experience, who enroll full time, may enter the Signal Corps Enlisted Reserve for training with pay. Graduate Electrical Engineers may apply for immediate commissions in the Signal Corps.

Civilians over 16 years of age may attend a Signal Corps School, and will be paid not less than \$1020 per year for full-time training and future service with the Signal Corps. Apply U. S. Employment Bureau or U. S. Civil Service.

**"KEEP 'EM FLYING!"**



**U.S. ARMY RECRUITING AND INDUCTION SERVICE**

Visit or write the nearest U. S. Army Recruiting and Induction Station or write to: "The Commanding General," of the Service Command nearest you, or Procurement Branch, AL-2, A.G.O., Washington, D. C.

FOR OUTSTANDING ACHIEVEMENT

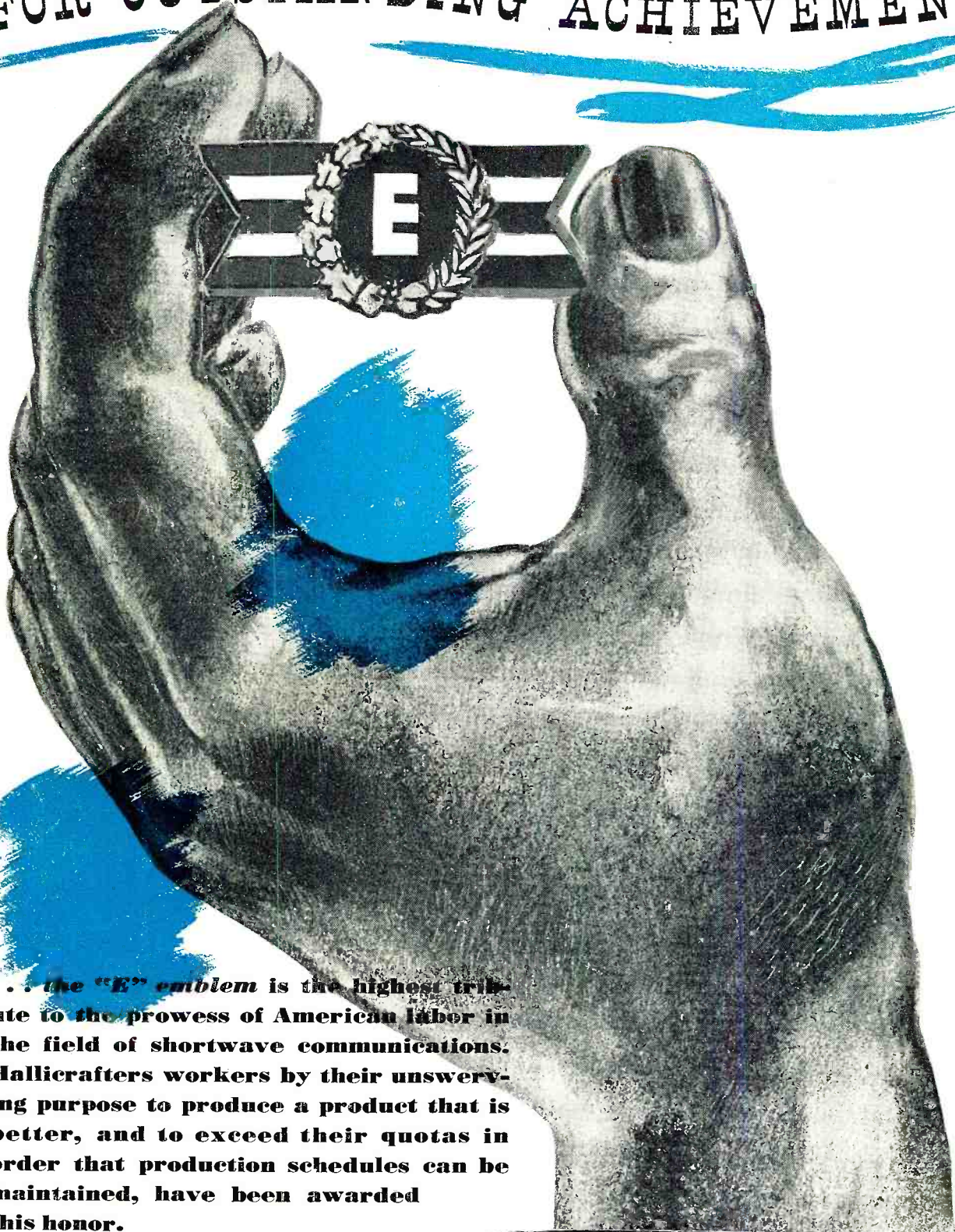

... the "E" emblem is the highest tribute to the prowess of American labor in the field of shortwave communications. Hallicrafters workers by their unswerving purpose to produce a product that is better, and to exceed their quotas in order that production schedules can be maintained, have been awarded this honor.

The accumulative electronic experience gained by Hallicrafters employes will be a dominant factor in future peace time production of advanced designs in shortwave communications receivers.

LALONDE  
NEWS AGENCY  
DIAL 4-1711

[www.americanradiohistory.com](http://www.americanradiohistory.com)

the hallicrafters co.  
CHICAGO, U. S. A.

*Keep Communications Open!*

NOV 27 1942

-24